



















**Prese ad Innesto Rapido - Quick Couplings - Schnellverschluss Kupplungen**  
*Coupleurs Automatiques - Enchufes Rápidos - Conexões de Engate Rápido*

<p>SERIE UNI ISO 6150 A-6</p>  <p><b>Serie 100</b> Pag. 15.7 - 15.10</p>	<p>SERIE MIGNON</p>  <p><b>Serie 110</b> Pag. 15.11 - 15.16</p>	<p>SERIE UNI ISO 6150 B-12</p>  <p><b>Serie 120</b> Pag. 15.17 - 15.22</p>	<p>ITALIAN PROFILE</p>  <p><b>Serie 120</b> Pag. 15.23 - 15.28</p>	<p>SERIE UNI ISO 6150 B-15</p>  <p><b>Serie 130</b> Pag. 15.29 - 15.33</p>
<p>SERIE UNI ISO 6150 C-10</p>  <p><b>Serie 140</b> Pag. 15.34 - 15.39</p>	<p>EUROPEAN PROFILE</p>  <p><b>Serie 160</b> Pag. 15.40 - 15.45</p>	<p>SWISS PROFILE</p>  <p><b>Serie 170</b> Pag. 15.46 - 15.50</p>	<p>MIGNON PROFILE</p>  <p><b>Serie 180</b> Pag. 15.51 - 15.54</p>	<p>MULTISOCKET</p>  <p><b>Serie 190 - 63190</b> Pag. 15.55 - 15.61</p>
<p>JAPANESE PROFILE</p>  <p><b>Serie 400</b> Pag. 15.62 - 15.64</p>	<p>MINI DN 2,7</p>  <p><b>Serie 700</b> Pag. 15.65 - 15.67</p>	<p>SERIE UNI ISO 6150 B-17</p>  <p><b>Serie 710</b> Pag. 15.68 - 15.70</p>	<p>B-SOCKET EUROPEAN</p>  <p><b>Serie 720</b> Pag. 15.71 - 15.74</p>	<p>EUROPEAN PROFILE <b>New</b></p>  <p><b>Serie 730</b> Pag. 15.75 - 15.80</p>
<p>EUROPEAN PROFILE <b>New</b></p>  <p><b>Serie 740</b> Pag. 15.81 - 15.83</p>				

**Prese di Sicurezza ad Innesto Rapido - Safety Quick Couplings - Kupplungen Sicherheit - Coupleurs de Sécurité**  
*Enchufes de Seguridad - Conexões de Segurança*

<p>SERIE UNI ISO 6150 B-12</p>  <p><b>Serie 620</b> Pag. 15.87 - 15.88</p>	<p>ITALIAN PROFILE</p>  <p><b>Serie 650</b> Pag. 15.89 - 15.90</p>	<p>EUROPEAN PROFILE</p>  <p><b>Serie 660</b> Pag. 15.91 - 15.92</p>	<p>SWISS PROFILE</p>  <p><b>Serie 670</b> Pag. 15.93 - 15.94</p>	<p>SERIE UNI ISO 6150 B-12 <b>New</b></p>  <p><b>Serie 0B120</b> Pag. 15.97 - 15.99</p>
<p>SERIE UNI ISO 6150 C-10 <b>New</b></p>  <p><b>Serie 0B140</b> Pag. 15.100 - 15.102</p>				

**Giunti ad Innesto Rapido per Raffreddamento Stampi - Quick Couplings for Molding Cooling - Schnellkupplungen für Spritzgussanwendungen**  
*Coupleurs pour Moules D'injection - Enchufes Rápidos para Refrigeración de Moldes - Conexões de Engate Rápido para Resfriamento de Moldes*

<p>FRENCH PROFILE DN 8 - DN 12</p>  <p><b>Series 410-420 - 510 - 520</b> Pag. 15.104 - 15.110</p>	<p>INTERNATIONAL PROFILE DN 6 - DN 9</p>  <p><b>Series 430-440 - 530 - 540</b> Pag. 15.112 - 15.119</p>	<p>EUROPEAN PROFILE DN 6 - DN 9</p>  <p><b>Series 460-470 - 560 - 570</b> Pag. 15.120 - 15.127</p>
--	--	---

**Pistole di Soffiaggio - Blow Guns - Blaspistolen - Soufflertes - Pistolas Sopladoras - Pistola de Ar**

 <p><b>Series 360</b> Pag. 15.129 - 15.130</p>	 <p><b>Series 300</b> Pag. 15.131 - 15.133</p>	 <p><b>Spare Parts</b> Pag. 15.134</p>	 <p><b>Series 340</b> Pag. 15.135 - 15.136</p>
---	---	---	--

**GIUNTI AD INNESTO RAPIDO E PISTOLE AD ARIA**

*AUTOMATIC QUICK COUPLINGS AND BLOW GUNS*

*SCHNELLVERSCHLUSS-KUPPLUNGEN UND BLASPISTOLEN*

*COUPLEURS AUTOMATIQUES ET SOUFFLETTES*

*ENCHUFES RÁPIDOS Y PISTOLAS DE AIRE*

*CONEXÕES DE ENGATE RÁPIDO E PISTOLAS DE AR*



**Serie Quick Couplings**

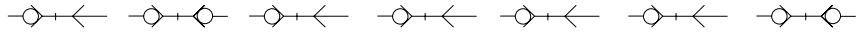

PLUG PROFILE 1:1	STANDARD	SINGLE SHUT OFF	DOUBLE SHUT OFF	STANDARD	MULTI	SAFETY	INOX	DOUBLE SHUT OFF	
	DN 5 MIGNON	<b>210</b> Pag. 15.11	<b>280</b> Pag. 15.51	<b>110</b> Pag. 15.11				<b>180</b> Pag. 15.51	
	DN 2.5 UNI-ISO 6150-A6	<b>200</b> Pag. 15.7		<b>100</b> Pag. 15.7					
	DN 5.5 UNI-ISO 6150-B12 INDUSTRIAL 1/4	<b>220</b> Pag. 15.17		<b>120</b> Pag. 15.17	<b>190</b> Pag. 15.55	<b>620</b> Pag. 15.87 <b>OB120</b> Pag. 15.97			
	DN 9 UNI-ISO 6150-B15 INDUSTRIAL 3/8	<b>230</b> Pag. 15.29		<b>130</b> Pag. 15.29	<b>720</b> Pag. 15.71				
	DN 12 UNI-ISO 6150-B17 INDUSTRIAL 1/2	<b>810</b> Pag. 15.68		<b>710</b> Pag. 15.68					
	DN 5.5 UNI-ISO 6150-C10	<b>240</b> Pag. 15.34		<b>140</b> Pag. 15.34		<b>OB140</b> Pag. 15.100			
	DN 7.5 - 7.8 EUROPEAN	<b>260</b> Pag. 15.40	<b>63260</b> Pag. 15.59	<b>840</b> Pag. 15.81	<b>160</b> Pag. 15.40 <b>730</b> Pag. 15.75	<b>190</b> Pag. 15.55	<b>660</b> Pag. 15.91	<b>63190</b> Pag. 15.59	<b>740</b> Pag. 15.81
	DN 10 EUROPEAN DN 10	<b>820</b> Pag. 15.71		<b>720</b> Pag. 15.71					
	DN 5.5 SWISS	<b>270</b> Pag. 15.46		<b>170</b> Pag. 15.46	<b>190</b> Pag. 15.55	<b>670</b> Pag. 15.93			
	DN 7.5 JAPANESE	<b>500</b> Pag. 15.62		<b>400</b> Pag. 15.62					
	DN 5 ITALIAN	<b>250</b> Pag. 15.23		<b>120</b> Pag. 15.23	<b>190</b> Pag. 15.55	<b>650</b> Pag. 15.89			
	DN 2.7 MINI	<b>800</b> Pag. 15.65		<b>700</b> Pag. 15.65					
	DN 8 FRENCH	<b>510</b> Pag. 15.106		<b>410</b> Pag. 15.106					
	DN 12 FRENCH	<b>520</b> Pag. 15.109		<b>420</b> Pag. 15.109					
	DN 6 INTERNATIONAL	<b>530</b> Pag. 15.114		<b>430</b> Pag. 15.114					
	DN 9 INTERNATIONAL	<b>540</b> Pag. 15.117		<b>440</b> Pag. 15.117					
	DN 6 EUROPEAN	<b>560</b> Pag. 15.122		<b>460</b> Pag. 15.122					
	DN 9 EUROPEAN	<b>570</b> Pag. 15.125		<b>470</b> Pag. 15.125					

WATER OIL

RECTUS/PARKER 21/90	CAMOZZI 5050 - 5150	CEJN 200		FESTO KD - KS 2	
RECTUS/LEGRIS 23/24 PARKER 20/30 - 1/4 TEMA 1400	HANSEN 3000	CEJN 310	INDUSTRIAL 1/4	GROMELLE 600	US - MIL SPEC C-4109
RECTUS/LEGRIS 30 PARKER 30 - 3/8	HANSEN 4000	CEJN 430	INDUSTRIAL 3/8	GROMELLE 900	US - MIL SPEC C-4109
RECTUS 37	HANSEN 5000	CEJN 550		GROMELLE 1300	US - MIL SPEC C-4109
RECTUS/LEGRIS 18					
RECTUS/LEGRIS 25/26/1600/1625 TEMA 1600	CAMOZZI 5080 - 5180	CEJN 320		FESTO KD - KS 6 KD - KS 4	
RECTUS/LEGRIS 27		CEJN 410			
RECTUS/LEGRIS 14/22 PARKER 50	HANSEN 210	CEJN 300		ARO 210	
RECTUS/LEGRIS 13	SMC KK130	CEJN 315	NITTO KOHKI 200		
RECTUS/LEGRIS PARKER 20/91				FESTO KD - KS 2	
RECTUS 608					
RECTUS 612					
RECTUS 86	DME 1/4				
RECTUS 87	DME 3/8				
RECTUS 10	HASCO Z80/811HT/9 [Øe 9]	CEJN 220 - 221 - 225			
RECTUS 11	HASCO Z80/811HT/13 [Øe 13.5]				

La gamma dei giunti ad innesto rapidi Aignep permette una risposta adeguata ai molteplici bisogni dei nostri clienti. Le differenti applicazioni, le prestazioni e l'affidabilità, sono i vantaggi dati dall'insieme di questa importantissima gamma.

A semplice o doppia intercettazione in ottone nichelato, in acciaio inox, conformi alle principali norme di riferimento possono essere utilizzati per veicolare molteplici fluidi.

A completamento pistole di soffiaggio.

#### Principali vantaggi

- Passaggi da DN 2,5 a 12 mm
- Profili normalizzati
- Gamme Multipresa
- Montaggio con una sola mano
- Leggerezza ed ingombro ridotto
- Versioni di sicurezza
- Raffreddamento stampi normalizzati
- Silicon Free

#### Applicazioni

- Impianti Aria Compressa e Strumenti
- Automazione Pneumatica e Fluidica
- Food & Beverage
- Life & Sciences
- Raffreddamento stampi
- Gas inerti, versioni per vuoto

*Aignep range of quick couplings is able to satisfy multiple needs of our customers.*

*Wide variety of models: single & double shut-off, multisocket, safety.*

*The most popular profiles and nominal diameters available in nickel-plated brass and stainless steel.*

*For compressed air and for moulding injection cooling system.*

*To complete the line a wide range of air blow guns.*

#### Main advantages

- DN 2,5 - 12 mm
- Standard profiles
- Multisocket
- Single handed operation
- Light and compact
- Safety version
- Moulding couplers
- Silicon Free

#### Applications

- Compressed Air & Tools
- Pneumatic & Fluidtechnology
- Food & Beverage
- Life & Sciences
- Cooling System
- Inert Gases, Vacuum

*Die Schnellverschlusskupplungs-Serie von Aignep antwortet auf die vielfältigen Bedürfnisse unserer Kunden. Zahlreiche verschiedene Modelle: Einzel- und Doppelabsperrung, Mehrfachstecker, Sicherheitskupplungen.*

*Die beliebtesten Profile und Nennweiten sind aus vernickeltem Messing und Edelstahl verfügbar.*

*Für Druckluft und für Spritzguss-Kühlsysteme zu formen. Zur Vervollständigung der Serie eine große Auswahl an Blaspistolen.*

#### Hauptvorteile

- DN 2,5 – 12 mm
- Standard Profile
- Mehrfachstecker
- Einhändige Bedienung
- Leicht und kompakt
- Sicherheits Versionen
- Spritzwerkzeug-Kühlung
- Silikonfrei

#### Anwendungen

- Druckluft & Werkzeuge
- Pneumatik und Fluidtechnik
- Lebensmittel & Getränke
- Life Science
- Kühlsysteme
- Inertgase, Vakuum

FR

Les coupleurs rapides Aignep répondent à de nombreuses utilisations. Grande variété de modèles en version simple et double obturation, multiprise, de sécurité. Les profils et les diamètres nominaux les plus courants sont disponibles en laiton nickelé et acier inoxydable 316L.

Pour air comprimé et tous fluides industriels ainsi qu'une gamme dédiée pour le refroidissement des moules dans l'injection plastique. Une large gamme de soufflettes vient compléter notre offre.

#### Principaux avantages

- DN 2,5 - 12 mm
- Profils standards
- Multisocket
- Opération d'une seule main
- Léger et compact
- Version de sécurité
- Coupleurs pour moule
- Sans silicone

#### Applications

- Air comprimé
- Outillage pneumatique
- Agro alimentaire
- Sciences de la vie
- Système de refroidissement
- Gaz neutres, vide

ES

La gama de enchufes rápidos Aignep permite una respuesta adecuada a las múltiples necesidades de nuestros clientes. Las diferentes aplicaciones, las prestaciones y la fiabilidad, son las ventajas que ofrece esta importantísima gama.

A simple y doble obturación en latón niquelado, acero inox, conforme a las principales normas de referencia pueden ser utilizados para vehicular múltiples fluidos. Completan esta gama las pistolas de soplado.

#### Principales ventajas

- Pasos de DN 2,5 a 12 mm
- Perfiles normalizados
- Gama Multipresa
- Montaje con una sola mano
- Ligereza y reducidas dimensiones
- Versión de seguridad
- Refrigeración de moldes normalizados
- Libres de silicona

#### Aplicaciones

- Instalaciones de aire comprimido y herramientas
- Automatización neumática y fluidica
- Alimentos y bebidas
- Life & Science
- Refrigeración de moldes
- Gases inertes, versiones para vacío

PT

A linha de engates rápidos Aignep pode satisfazer as diferentes necessidades dos consumidores. Ampla gama: fechamento simples ou duplo, multisocket, segurança.

Os itens mais populares e diâmetros nominais estão disponíveis em latão niquelado ou aço inox.

A linha é adequada para ar comprimido e resfriamento de moldagem.

Completam a linha as pistolas de ar.

#### Principais Vantagens

- DN 2,5 - 12 mm
- Perfil-padrão
- Multisocket
- Instalação fácil - com uma só mão
- Leve e compacta
- Engate de Segurança
- Engates Resfriamento
- Livre de silicone

#### Aplicação

- Ar Comprimido & Ferramentas
- Pneumática & Tecnologia de Fluidos
- Alimentos e bebidas
- Life & Sciences
- Sistemas de Resfriamento
- Gases Inertes, Vácuo

**SERIE 160 EUROPEAN PROFILE**



**CARATTERISTICHE TECNICHE**  
 TECHNICAL CHARACTERISTICS  
 TECHNISCHE ANGABEN  
 CARACTÉRISTIQUES TECHNIQUES  
 CARACTERÍSTICAS TÉCNICAS  
 CARACTERÍSTICAS TÉCNICAS



**Norma di Riferimento**

Reference standard

Entspricht der Norm

Norme de référence

Normativa de referencia

Norma de referência

1907/2006  
**REACH** ✓

2011/65/CE  
**RoHS** ✓

PED  
 2014/68/UE

SILICON  
 FREE

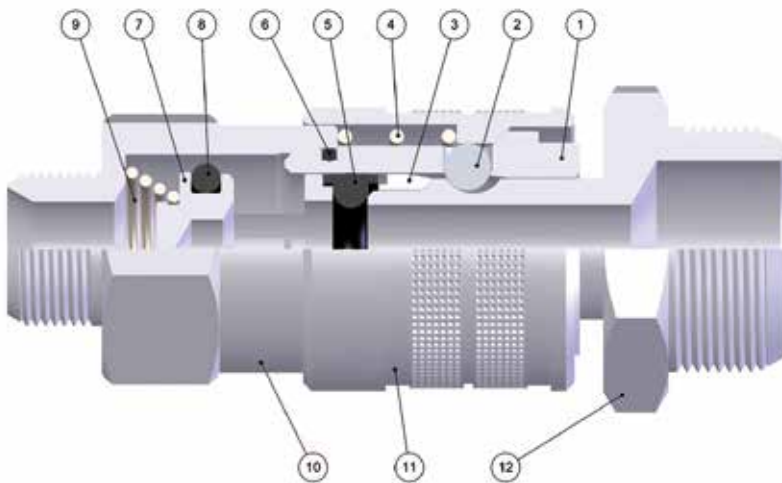

**FKM A RICHIESTA**  
 IF REQUESTED FKM  
 FKM AUF ANFRAGE  
 FKM SUR DEMANDE  
 FKM BAJO DEMANDA  
 FKM SOB ENCOMENDA

**DN**  
 7.5 - 7.8 mm

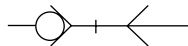

**EUROPEAN**

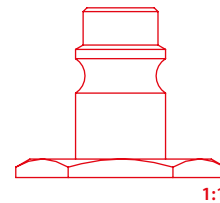

Materiali e Componenti	IT	Component Parts and Materials	GB	Komponenten und Materialien	DE
1 Corpo in Ottone Nichelato 2 Sfera in Acciaio AISI 420 3 Anello Guida Innesto in Ottone Nichelato 4 Molla Ghiera in Acciaio AISI 302 5 Guarnizione Innesto Sagomata in NBR 6 Guarnizione O-Ring in NBR 7 Otturatore in Ottone Nichelato 8 Guarnizione O-Ring in NBR 9 Molla Otturatore in Acciaio AISI 302 10 Attacco Terminale in Ottone Nichelato 11 Ghiera in Ottone Nichelato 12 Innesto in Ottone Nichelato		1 Nickel-Plated Brass Body 2 Stainless Steel AISI 420 Balls 3 Nickel-Plated Brass Guide Ring Coupling 4 Stainless Steel AISI 302 Ring Nut Spring 5 NBR Plug Molded Seals 6 NBR O-Ring Seals 7 Nickel-Plated Brass Shutter 8 NBR O-Ring Seals 9 Stainless Steel AISI 302 Shutter Spring 10 Nickel-Plated Brass Coupling Back Part 11 Nickel-Plated Brass Sleeve 12 Nickel-Plated Brass Plug Outline		1 Körper Messing Vernickelt 2 Kugel Edelstahl AISI 420 3 Stecker Führungsring Messing Vernickelt 4 Entriegelungsfeder Edelstahl AISI 302 5 O-Ring NBR 6 O-Ring NBR 7 Verschluss Messing Vernickelt 8 O-Ring NBR 9 Verschlussfeder Edelstahl AISI 302 10 Einschraubkörper Messing Vernickelt 11 Entriegelungshülse Messing Vernickelt 12 Stecker Messing Vernickelt	
Matériaux et Composants	FR	Materiales y Componentes	ES	Materiais e Componentes	PT
1 Corps: Laiton Nickelé 2 Bille: Acier Inoxydable AISI 420 3 Bague de Guidage: Laiton Nickelé 4 Ressort de Bague: Acier Inoxydable AISI 302 5 Joint Torique en NBR 6 Joint Torique en NBR 7 Clapet: Laiton Nickelé 8 Joint Torique en NBR 9 Ressort de Clapet: Acier Inoxydable AISI 302 10 Corps: Laiton Nickelé 11 Bague: Laiton Nickelé 12 Embout: Laiton Nickelé		1 Cuerpo en latón niquelado 2 Esfera en acero AISI 420 3 Anillo guía enchufe en latón niquelado 4 Muelle tuerca en acero AISI 302 5 Tapón obturador sagomata NBR 6 Junta tórica en NBR 7 Obturador en latón niquelado 8 Junta tórica en NBR 9 Muelle obturador en acero AISI 302 10 Terminal de conexión en latón niquelado 11 Tuerca en latón niquelado 12 Enchufe en latón niquelado		1 Corpo em Latão Niquelado 2 Esfera em aço AISI 420 3 Anel guia do plug em latão niquelado 4 Mola da porca em aço AISI 302 5 Vedações em NBR moldada para plug 6 Vedação O-Ring em NBR 7 Obturador em latão niquelado 8 Vedação O-Ring em NBR 9 Mola do obturador em aço AISI 302 10 Conexão terminal em latão niquelado 11 Porca em latão niquelado 12 Plug em latão niquelado	



### Pressione d'esercizio

Working Pressures

Betriebsdruck

Pression de service

Presión de Ejercicio

Pressão de Trabalho

**0 bar**

**16 bar**



### Max pressione statica (no pulsazioni)

Maximum static pressure (no pulsations)

Maximaler statischer Betriebsdruck (ohne pulsations)

Pression statique maximale (sans pulsation)

Presión estática máxima (sin pulsaciones)

Pressão estática máxima (sem pulsações)

**35 bar**



### Temperature

Temperatures

Temperatur

Températures

Temperaturas

Temperaturas

**- 20 °C**

**+ 80 °C**

Con O-ring in FKM

With FKM O-ring

Mit O-ring in FKM

Avec joints en FKM

Con junta tórica en FKM

Com O-ring em FKM

**- 10 °C**

**+ 200 °C**



### Fluidi compatibili

Aria compressa

Fluids

Compressed air

Geeignete Medien

Druckluft

Fluides compatibles

Air comprimé

Fluidos compatibles

Aire comprimido

Fluidos compatíveis

Ar comprimido

Per altri fluidi, consultare l'ufficio tecnico Aignep.

For other fluids, consult the technical department Aignep.

Für andere Flüssigkeiten, kontaktieren Sie uns.

Pour d'autres fluides, veuillez nous consulter.

Para otros fluidos póngase en contacto con el departamento técnico Aignep.

Para outros fluidos consulte o departamento técnico da Aignep.



### Portata

NI/min

Flow Rate

Durchflusswerte

Débit

Caudal de Flujo

Vazão

DN	6 bar Δ 1	6 bar Δ 0.5	6 bar Δ 0*
7.5	1750	1100	2400
7.8	1900	1300	2450

\* Scarico libero - Exhaust Free - Kostenlose Auspuff - Échappement libre - Escape Libre - Descarga livre.



### Filettatura

IT

Gas cilindrica conforme ISO 228 Classe A.

### Threads

GB

Parallel gas in conformity with ISO 228 Class A.

### Gewindearten

DE

Zylindrisches Gewinde nach Norm ISO 228 Classe A.

### Filetages

FR

Filetage cylindrique conforme: ISO 228 Classe A.

### Roscas

ES

Gas cilindrica conforme ISO 228 Clase A.

### Roscas

PT

Gas paralela conforme ISO 228 Classe A.



# 161

**PRESA MASCHIO**
*MALE SOCKET*
*VERSCHLUSS-KUPPLUNG MIT AUSSENGEWINDE*
*COUPLEUR MÂLE*
*ENCHUFE MACHO*
*SOQUETE COM ROSCA MACHO*

Code	A	B	C	D	CH	Pack.
00161 00 001	1/4	8	48	24	21	10
00161 00 002	3/8	9	49	24	21	10
00161 00 003	1/2	10	50	24	24	10

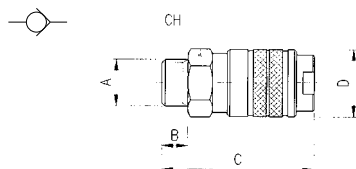

# 162

**PRESA FEMMINA**
*FEMALE SOCKET*
*VERSCHLUSS-KUPPLUNG MIT INNENGEWINDE*
*COUPLEUR FEMELLE*
*ENCHUFE HEMBRA*
*SOQUETE COM ROSCA FÊMEA*

Code	A	B	C	D	CH	Pack.
00162 00 001	1/4	11	51	24	21	10
00162 00 002	3/8	11.5	51.5	24	21	10
00162 00 003	1/2	14	55	24	24	10

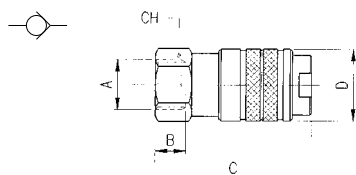

# 163

**PRESA A CALZAMENTO CON MOLLA**
*COMPRESSION SOCKET WITH SPRING*
*VERSCHLUSS-KUPPLUNG MIT KNICKSCHUTZFEDER*
*COUPLEUR AVEC RESSORT DE PROTECTION*
*ENCHUFE TUBO CON MUELLE*
*SOQUETE COM CONEXÃO PUSH-ON COM MOLA*

Code	A	B	C	D	CH	Pack.
00163 00 001	6/4	-	138	24	21	10
00163 00 002	8/6	-	143.5	24	21	10
00163 00 003	10/8	-	151	24	21	10
00163 00 007	12/10	-	161.5	24	21	10

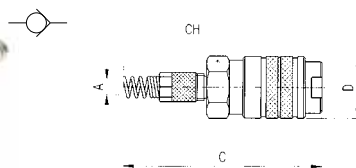

# 164

**PRESA A CALZAMENTO**
*COMPRESSION SOCKET*
*VERSCHLUSS-KUPPLUNG MIT ÜBERWURFVERSCHRAUBUNG*
*COUPLEUR RACCORD À COIFFE*
*ENCHUFE TUBO*
*SOQUETE COM CONEXÃO PUSH-ON*

Code	A	B	C	D	CH	Pack.
00164 00 001	6/4	-	59	24	21	10
00164 00 002	8/6	-	59	24	21	10
00164 00 003	10/8	-	60	24	21	10
00164 00 007	12/10	-	62	24	21	10

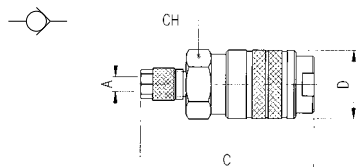

## 165

### PRESA CON PORTAGOMMA A RESCA

SOCKET WITH REST FOR RUBBER HOSE  
 VERSCHLUSS-KUPPLUNG MIT SCHLAUCHTÜLLE  
 COUPLEUR À DOUILLE ANNELÉE POUR TUBE  
 ENCHUFE ESPIGA  
 SOQUETE COM ESPIGÃO PARA MANGUEIRA DE BORRACHA

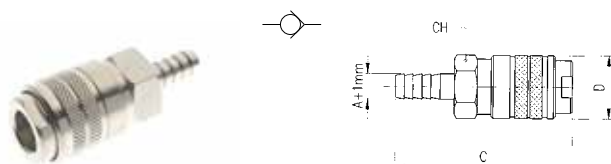

Code	A	B	C	D	CH	Pack.
00165 00 001	6	-	61	24	21	10
00165 00 002	8	-	61	24	21	10
00165 00 003	10	-	61	24	21	10
00165 00 004	12	-	61	24	21	10

## 166

### PRESA CON PORTAGOMMA

SOCKET FOR RUBBER HOSE  
 VERSCHLUSS-KUPPLUNG FÜR GUMMISCHLAUCH  
 COUPLEUR À DOUILLE ANNELÉE POUR TUBE  
 ENCHUFE CON PORTAGOMA  
 SOQUETE COM ESPIGÃO PARA TUBO DE BORRACHA

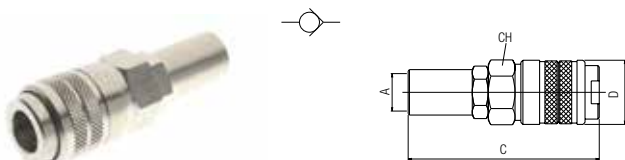

Code	A	B	C	D	CH	Pack.
00166 00 001	14/6	-	80	24	21	10
00166 00 002	17/8	-	84	24	21	10
00166 00 003	19/10	-	85	24	24	10

## 261

### INNESTO MASCHIO

MALE PLUG  
 STECKER MIT AUSSENGEWINDE  
 EMBOUT MÂLE  
 ADAPTADOR MACHO  
 PLUG COM ROSCA MACHO

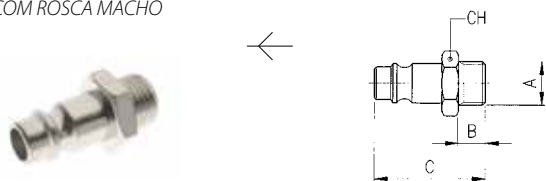

Code	A	B	C	D	CH	Pack.
00261 00 01 03 NB	1/4	8	33	-	17	10
00261 00 01 04 NB	3/8	9	34	-	19	10
00261 00 01 05 NB	1/2	10	35.5	-	24	10

## 261AC DN 7.8

### INNESTO IN ACCIAIO MASCHIO

STEEL MALE PLUG  
 STECKER MIT AUSSENGEWINDE AUS STAHL  
 EMBOUT MÂLE EN ACIER  
 ADAPTADOR EN ACERO MACHO  
 PLUG EM AÇO COM ROSCA MACHO

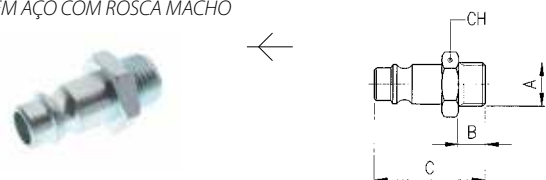

Code	A	B	C	D	CH	Pack.
261AC 00 51 03 ZI	1/4	8	33	-	17	10
261AC 00 51 04 ZI	3/8	9	34	-	19	10
261AC 00 51 05 ZI	1/2	10	35.5	-	24	10

**ACCIAIO INDURITO**  
 HARDENED STEEL  
 GEHÄRTETEM STAHL  
 ACIER TREMPÉ  
 ACERO CURTIDO  
 AÇO ENDURECIDO

## 262

### INNESTO FEMMINA

FEMALE PLUG  
 STECKER MIT INNENGEWINDE  
 EMBOUT FEMELLE  
 ADAPTADOR HEMBRA  
 PLUG COM ROSCA FÊMEA

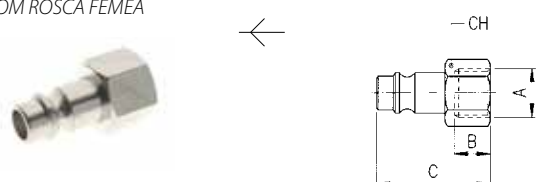

Code	A	B	C	D	CH	Pack.
00262 00 01 03 NB	1/4	11	33	-	17	10
00262 00 01 04 NB	3/8	11.5	33.5	-	19	10
00262 00 01 05 NB	1/2	14	36	-	24	10

## 262AC DN 7.8

### INNESTO IN ACCIAIO FEMMINA

STEEL FEMALE PLUG

STECKER MIT INNENGEWINDE AUS STAHL

EMBOUT FEMELLE EN ACIER

ADAPTADOR EN ACERO HEMBRA

PLUG EM AÇO COM ROSCA FÊMEA

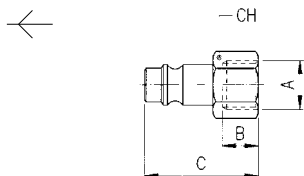

Code	A	B	C	D	CH	Pack.
262AC 00 51 03 ZI	1/4	11	33	-	17	10
262AC 00 51 04 ZI	3/8	11.5	33.5	-	19	10
262AC 00 51 05 ZI	1/2	14	36	-	24	10

ACCIAIO INDURITO  
HARDENED STEEL  
GEHÄRTETEM STAHL  
ACIER TREMPÉ  
ACERO CURTIDO  
AÇO ENDURECIDO

## 263

### INNESTO A CALZAMENTO CON MOLLA

COMPRESSION PLUG WITH SPRING

STECKER MIT KNICKSCHUTZFEDER

EMBOUT AVEC RESSORT DE PROTECTION

ADAPTADOR TUBO CON MUELLE

PLUG COM CONEXÃO PUSH-ON COM MOLA

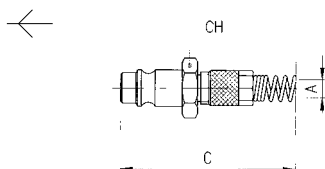

Code	A	B	C	D	CH	Pack.
00263 00 001	6/4	-	124.5	-	13	10
00263 00 002	8/6	-	130	-	13	10
00263 00 003	10/8	-	137.5	-	14	10
00263 00 004	12/10	-	143	-	16	10

## 264

### INNESTO A CALZAMENTO

COMPRESSION PLUG

STECKER MIT ÜBERWURFVERSCHRAUBUNG

EMBOUT À RACCORD À COIFFE

ADAPTADOR TUBO

PLUG COM CONEXÃO PUSH-ON

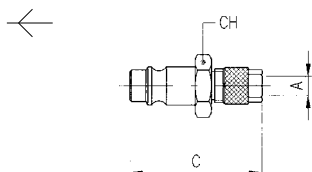

Code	A	B	C	D	CH	Pack.
00264 00 001	6/4	-	36	-	13	10
00264 00 002	8/6	-	36.5	-	13	10
00264 00 003	10/8	-	38.5	-	14	10
00264 00 004	12/10	-	47.5	-	16	10

## 265

### INNESTO CON PORTAGOMMA A RESCA

PLUG WITH REST FOR RUBBER HOSE

STECKER MIT SCHLAUCHTÜLLE

EMBOUT À DOUILLE ANNELÉE POUR TUBE

ADAPTADOR ESPIGA

PLUG COM ESPIGÃO PARA TUBO DE BORRACHA

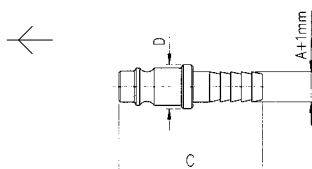

Code	A	B	C	D	CH	Pack.
00265 00 01 X4 NB	6	-	39.5	12	-	10
00265 00 01 X7 NB	8	-	39.5	12	-	10
00265 00 01 X9 NB	10	-	42.5	14	-	10
00265 00 01 Y1 NB	12	-	42.5	16	-	10

## 265AC DN 7.8

### INNESTO IN ACCIAIO CON PORTAGOMMA A RESCA

STEEL PLUG WITH REST FOR RUBBER HOSE

STECKER MIT SCHLAUCHTÜLLE AUS STAHL

EMBOUT À DOUILLE ANNELÉE POUR TUBE EN ACIER

ADAPTADOR EN ACERO ESPIGA

PLUG EM AÇO COM ESPIGÃO PARA TUBO DE BORRACHA

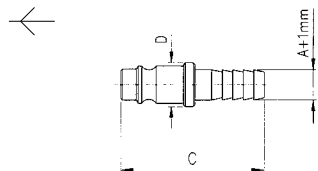

**ACCIAIO INDURITO**  
HARDENED STEEL  
GEHÄRTETEM STAHL  
ACIER TREMPÉ  
ACERO CURTIDO  
AÇO ENDURECIDO

Code	A	B	C	D	CH	Pack.
265AC 00 51 X4 ZI	6	-	39.5	12	-	10
265AC 00 51 X7 ZI	8	-	39.5	12	-	10
265AC 00 51 X9 ZI	10	-	42.5	14	-	10
265AC 00 51 Y1 ZI	12	-	42.5	16	-	10

## 266

### INNESTO CON PORTAGOMMA

PLUG FOR RUBBER HOSE

STECKER FÜR GUMMISCHLAUCH

EMBOUT POUR TUBE

ADAPTADOR CON PORTAGOMA

PLUG COM ESPIGÃO PARA TUBO DE BORRACHA

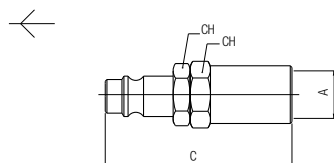

Code	A	B	C	CH1	CH2	Pack.
00266 00 001	14/6	-	55	15	17	10
00266 00 002	17/8	-	55	15	20	10
00266 00 003	19/10	-	55	15	22	10

## 267

### INNESTO A BAIONETTA

BAYONET PLUG

STECKER MIT BAJONETT-VERSCHLUSS

EMBOUT À BAIONNETTE

ADAPTADOR BAYONETA

PLUG COM CONEXÃO TIPO BAIONETA

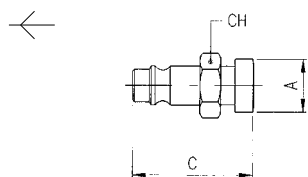

Code	A	B	C	D	CH	Pack.
00267 00 001	15	-	33.5	-	15	10

## 268

### INNESTO A SCARICO PROGRESSIVO

PLUG WITH GRADUAL EXHAUST

STECKER MIT PROGRESSIVER ENTLASTUNG

EMBOUT À PASSAGE PROGRESSIF

ADAPTADOR DE DESCARGA PROGRESIVA

PLUG COM ESCAPE PROGRESSIVO

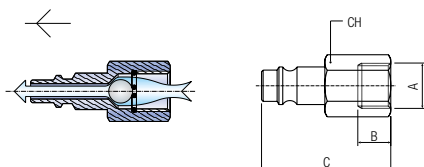

Code	A	B	C	CH	Pack.
00268 00 001	1/4	11	41.5	17	10



Aignep si riserva il diritto di variare modelli e ingombri senza preavviso.  
Aignep reserves the right to vary models and dimensions without notice.  
Aignep behält sich das Recht vor, Daten ohne Ankündigung zu ändern.  
Aignep se réserve le droit de modifier les données sans préavis.  
Aignep reserva-se o direito de alterar os modelos e dimensões sem prévio aviso.

**Aggiornamento - Updated - Stand - Mise à jour - Actualización - Atualização: 11/2018**



**AIGNEP SPA**  
Via Don G. Bazzoli - 34  
25070 Bione (BS)  
**ITALY**

**T: +39 0365 896626**  
**F: +39 0365 896561**

[aignep.it@aignep.com](mailto:aignep.it@aignep.com)



**AIGNEP IBERICA SA**  
Pol. Ind. el Tortuguer "Can Prat"  
Naves 23 y 24 08691  
Monistrol de Montserrat - Barcelona  
**SPAIN**

**T: +34 93 828 47 36**  
**F: +34 93 828 44 32**

[aignep.es@aignep.com](mailto:aignep.es@aignep.com)



**AIGNEP DO BRASIL COMERCIO DE  
COMPONENTES PARA AUTOMAÇÃO LTDA**  
Rua Campos Mello, 185  
Vila Mathias - 11015-011 - Santos/SP  
**BRASIL**

**T: +55 13 2138 4049**  
**F: +55 13 2138 4052**

[aignep.br@aignep.com](mailto:aignep.br@aignep.com)



**AIGNEP USA LLC**  
7121 Loblolly Pine Blvd  
Fairview, TN 37062  
**U.S.A.**

**T: +1 615 771 6650**  
**F: +1 615 771 0926**

[aignep.usa@aignep.com](mailto:aignep.usa@aignep.com)



**AIGNEP AG**  
Industriestrasse 22A  
2545 Selzach  
**SWITZERLAND**

**T: +41 32 342 09 09**  
**F: +41 32 342 09 11**

[aignep.ch@aignep.com](mailto:aignep.ch@aignep.com)



**AIGNEP FRANCE SARL**  
2, Avenue des Améthystes  
44338 Nantes Cedex 3  
**FRANCE**

**T: +33 02 72 24 26 50**  
**F: +33 02 72 24 26 51**

[aignep.fr@aignep.com](mailto:aignep.fr@aignep.com)



**AIGNEP LATAM**  
Sede:  
Calle 15 N 27-78 Local 2  
Sec. Paloquemao - 111411  
Bogota  
**COLOMBIA**

**T: +57 1 37 52 50 1**  
**T: +57 1 37 52 50 8**

Sucursal:  
Calle 6 SUR 52-80 Local 19  
Cc. El Rodeo - 0520024 Medellin  
**COLOMBIA**

**T: +57 4 58 70 90 1**

[aignep.latam@aignep.com](mailto:aignep.latam@aignep.com)



**AIGNEP (Wuxi) FLUID  
TECHNOLOGY CO., LT D.**  
NO 8, Yanggong Road, Nanhu Main Road  
Wuxi, Jiangsu.  
**CHINA**

**T: 0510-8544 1923**  
**F: 0510-8540 0223**

[aignep.cn@aignep.com](mailto:aignep.cn@aignep.com)

[www.aignep.com](http://www.aignep.com)