

















































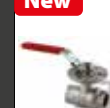
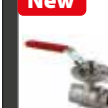

Serie Ghilux

 6300 Pag. 13.9	 6310 Pag. 13.9	 6320 Pag. 13.9	 6330 Pag. 13.9	 6340 Pag. 13.10	 6350 Pag. 13.10	 6400 Pag. 13.10	 6410 Pag. 13.10	 6420 Pag. 13.11
 6430 Pag. 13.11	 6440 Pag. 13.11	 6450 Pag. 13.12	 6460 Pag. 13.12	 6470 Pag. 13.12	 6490 Pag. 13.13	 6500 Pag. 13.13	 6540 Pag. 13.13	 6560 Pag. 13.14
 6570 Pag. 13.14	 6600 Pag. 13.14	 86300 Pag. 13.15	 86310 Pag. 13.15	 66300 Pag. 13.17	 66310 Pag. 13.17	 6700 Pag. 13.19	 6710 Pag. 13.20	 6720 Pag. 13.20
 6900 Pag. 13.21	 6910 Pag. 13.21	 6915 Pag. 13.21	 6920 Pag. 13.22	 6680 Pag. 13.22	 10740 Pag. 13.22	 10741 Pag. 13.22	 10760 Pag. 13.23	 10761 Pag. 13.23
 6065 Pag. 13.25	 6066 Pag. 13.25	 6067 Pag. 13.27	 6068 Pag. 13.27	 6069 Pag. 13.28	 6074 Pag. 13.31	 6075 Pag. 13.32	 6750L Pag. 13.34	 6755L Pag. 13.35
 6760L Pag. 13.35	 6765L Pag. 13.36	 LUC01 Pag. 13.36	 6035 Pag. 13.38	 6036 Pag. 13.40	 6037 Pag. 13.40	 6038 Pag. 13.40		

VALVOLE A SFERA

BALL VALVES

KUGELHÄHNE

ROBINETS A BOISSEAU SPHÉRIQUE

VÁLVULAS A ESFERA

VÁLVULAS DE ESFERA



Serie Ghilux

Inventate e ingegnerizzate da Aignep le valvole a sfera Ghilux sono state una rivoluzione già negli anni 90'. Di minimi ingombri e performanti queste micro valvole sono la risposta ottimale alla crescente richiesta di miniaturizzazione. Disponibili a 2 e 3 vie, con sfiato e attraversamento parete sono disponibili in ben 25 modelli differenti, possono intercettare differenti tipologie di fluidi. Possibilità di realizzare rubinetti con tenute differenti in FKM, EPDM e HNBR. Versione in Aisi 316L. A completamento dell'offerta Aignep dispone di rubinetti a 2 e 3 vie di dimensioni tradizionali.

Principali vantaggi

- A 2 e 3 vie e con spurgo
- Da 1/8 a 3/4 nelle filettature BSPP, BSPT e NPT
- Passaparete
- Tenute differenti in base alle applicazioni
- Leggerezza ed ingombro ridotto
- Inserti intercambiabili colorati per identificazione
- Silicon Free

Applicazioni

- Aria Compressa e Strumenti
- Automazione Pneumatica
- Intercettazione Fluidi
- Food & Beverage
- Life & Sciences
- Gas inerti, vuoto
- Settore Termoidraulico

The GHILUX miniature ballvalves have been created and engineered by Aignep in the 90's. The supercompact dimensions and the excellent performance respond to the growing demand of miniaturization.

Many available version: 2 or 3-ways, with exhaust, push-in, compression, etc.

25 different configurations to drive multiple fluids. On demand FKM, EPDM e HNBR.

To complete the range traditional ball valves.

Main advantages

- 2-3 ways with exhaust
- Threads 1/8 to 3/4 - BSPP, BSPT, NPT
- Bulkhead
- Multiple fluids
- Supercompact dimension
- Coloured plates for Identification
- Silicon Free

Applications

- Compressed Air, Tools
- Pneumatic Automation
- Fluidtechnology
- Food & Beverage
- Life & Sciences
- Inert Gases, Vacuum
- Plumbing

Die GHILUX Miniatur-Kugelhähne wurden in den 90er Jahren von Aignep entwickelt und kreiert.

Die superkompakten Abmessungen und die ausgezeichnete Leistung antworten auf die wachsende Nachfrage nach Miniaturisierung. Viele erhaltliche Versionen: 2 oder 3-Wege, mit Entlüftung, mit Steckanschluss, etc.

25 verschiedene Konfigurationen für den Transport vieler Medien. Auf Anfrage FKM, EPDM und HNBR Dichtungen. Als Ergänzung zum traditionellen Kugelhahn Sortiments.

Hauptvorteile

- 2-3 Wege mit Entlüftung
- Gewinde 1/8 bis 3/4" - BSPP, BSPT, NPT
- Schottmontage
- Verschiedene Medien
- Superkompakte Abmessung
- Farbige Schilder zur Kennzeichnung
- Silikonfrei

Anwendungen

- Druckluft, Werkzeuge
- Pneumatische Automation
- Fluidtechnik
- Lebensmittel & Getränke
- Life Sciences
- Inertgase, Vakuum
- Sanitär

Les robinets à boisseau sphérique GHILUX ont été conçus par Aignep dans les années 90. L'extrême compacité et l'excellente performance des produits répondent aux demandes croissantes dans la miniaturisation. Nombreuses versions disponibles: 2 ou 3 voies, avec échappement, raccordement instantané, à olive, etc. 25 configurations différentes pour transporter différents fluides. Version avec joint FKM, EPDM HNBR sur demande. Les robinets GHILUX complètent notre offre de robinets standards à boisseau sphérique.

Principaux avantages

- 2-3 voies, male - femelle- avec échappement
- Filetages de 1/8 à 3/4 - BSPP, BSPT, NPT
- A traversée de cloison
- Nombreux fluides
- Extrême compacité
- Plaques de couleur pour l'identification des circuits
- Sans Silicone

Applications

- Air comprimé
- Automatismes pneumatiques
- Agro alimentaire
- Laboratoire
- Gaz neutres, vide
- Plomberie

Inventadas y desarrolladas por Aignep las válvulas de esfera Ghilux eran ya una revolución en los años 90'. De reducidas dimensiones y excelente rendimiento estas micro válvulas son la respuesta óptima a la creciente demanda de miniaturización. Disponibles de 2 y 3 vías, con escape, automáticas, pasatabiques, compresión, 25 diferentes configuraciones para interceptar diferentes tipologías de fluidos. Posibilidad bajo demanda en FKM, EPDM y HNBR. Versión en Inox AISI 316L. Para completar la gama Aignep dispone de válvulas de esfera 2 y 3 vías de dimensiones tradicionales.

Principales ventajas

- A 2 y 3 vías y con escape
- De 1/8 a 3/4 con roscas BSPP, BSPT y NPT
- Pasatabiques
- Estanqueidad diferente en base a las aplicaciones
- Ligereza y dimensiones reducidas
- Insertos intercambiables de color para identificación
- Libres de silicona

Aplicaciones

- Aire comprimido y herramientas
- Automatización neumática
- Interceptación de fluidos
- Alimentos y bebidas
- Life & Sciences
- Gases inertes, vacío
- Sector termo hidráulico

As válvula-esfera miniatura da série GHILUX foram criadas e desenvolvidas pela Aignep nos anos 90. As dimensões super-compactas e a excelente performance, atende ao crescimento de demanda de miniaturização solicitada pelo mercado moderno. Várias versões estão disponíveis: 2 ou 3-vias, com exaustão, conexão push-in, conexão de compressão, etc. 25 configurações diferentes para conduzir múltiplos fluidos. Sob encomenda: vedações em FKM, EPDM e HNBR para completar o range tradicional das válvulas-esfera.

Principais vantagens

- 2-3 vias com escape
- Roscas de 1/8 a 3/4 - BSPP, BSPT, NPT
- Modelo passa-muro
- Múltiplos fluidos
- Dimensões Super-compactas
- Linguetas coloridas para fácil identificação
- Livre de Silicone

Aplicações

- Ar Comprimido, Ferramentas
- Automação Pneumática
- Fluidos
- Alimentos e Bebidas
- Life & Sciences
- Gases Inertes, Vácuo
- Encanamento



CARATTERISTICHE TECNICHE

TECHNICAL CHARACTERISTICS
 TECHNISCHE ANGABEN
 CARACTÉRISTIQUES TECHNIQUES
 CARACTERÍSTICAS TÉCNICAS
 CARACTERÍSTICAS TÉCNICAS



Norma di Riferimento

Reference standard
 Entspricht der Norm
 Norme de référence
 Normativa de referencia
 Norma de referência

1907/2006

REACH

2011/65/CE

RoHS

PED

2014/68/UE

BS EN
331:2015

SILICON
FREE

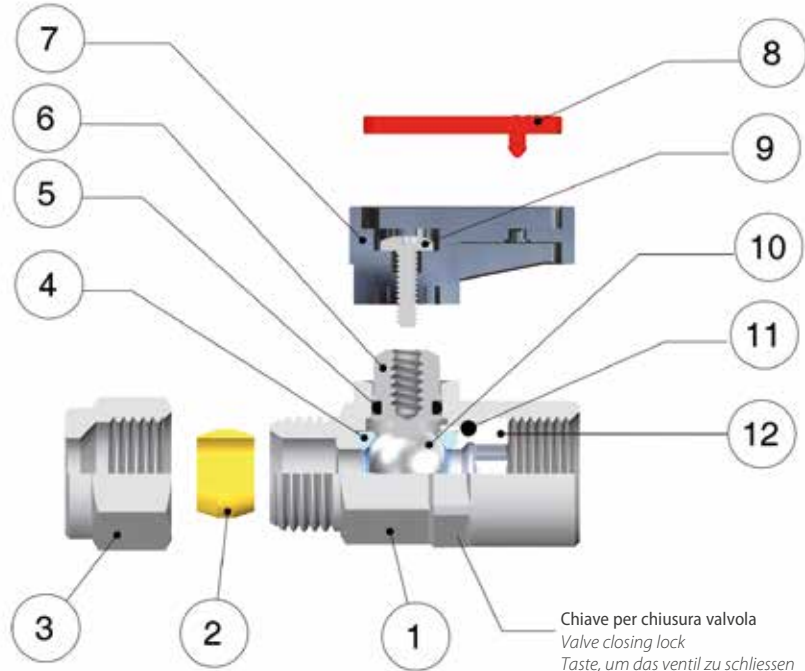

Chiave per chiusura valvola
 Valve closing lock
 Taste, um das Ventil zu schliessen
 Clé pour vanne de fermeture
 Llave para el cierre de la válvula
 A chave para o fecho da válvula

*** FKM - EPDM - HNBR A RICHIESTA**
 IF REQUESTED FKM - EPDM - HNBR
 FKM - EPDM - HNBR AUF ANFRAGE
 FKM - EPDM - HNBR SUR DEMANDE
 FKM - EPDM - HNBR BAJO PEDIDO
 FKM - EPDM - HNBR SOB ENCOMENDA

Materiali e Componenti	IT	Component Parts and Materials	GB	Komponenten und Materialien	DE
1 Corpo in Ottone cromato		1 Chrome Nickel-plated Brass Body		1 Körper Messing verchromt	
2 Ogiva in Ottone (PTFE a richiesta)		2 Brass Olive (if requested PTFE)		2 Klemmring Messing (PTFE auf Anfrage)	
3 Dado in Ottone cromato		3 Chrome Nickel-plated Brass Nut		3 Überwurfmutter Messing verchromt	
4 Guarnizione sede sfera in PTFE		4 PTFE Seats		4 Kugelsitzdichtung PTFE	
5 Guarnizione O-RING in NBR (FKM-EPDM-HNBR a richiesta)		5 NBR Seal O-RING (FKM-EPDM-HNBR if required)		5 O-Ring NBR (FKM-EPDM-HNBR auf Anfrage)	
6 Albero in Ottone cromato		6 Chrome Nickel-plated Brass Spindle		6 Spindel Messing verchromt	
7 Maniglietta in PA66 Caricato vetro		7 PA66 Glass reinforced Handle		7 Handgriff PA66 Glasfaser verstärkt	
8 Piastrina in Resina Acetalica		8 Acetalic resin Plate		8 Griffplatte Acetal	
9 Vite in acciaio		9 Steel Screw		9 Schraube Stahl	
10 Sfera in Ottone cromato		10 Chrome Nickel-plated Brass Ball		10 Kugel Messing verchromt	
11 Guarnizione O-RING in NBR*		11 NBR Seal O-RING*		11 O-Ring NBR*	
12 Ghiera o raccordo in Ottone		12 Brass Fitting		12 Gewindeinsatz Messing	
Matériaux et Composants	FR	Materiales y Componentes	ES	Materiais e Componentes	PT
1 Corps: laiton chromé		1 Cuerpo en latón cromado		1 Corpo em Latão Cromado	
2 Bague: laiton (sur demande en PTFE)		2 Bicono en latón (PTFE bajo demanda)		2 Bucha em Latão (PTFE sob encomenda)	
3 Ecrou: laiton nickelé		3 Tuerca en latón cromado		3 Porca em Latão Cromado	
4 Joint bille sphérique: PTFE		4 Junta sede esfera en PTFE		4 Vedação da sede da esfera em PTFE	
5 Joint tige NBR (sur demande en FKM-EPDM-HNBR)		5 Junta tórica O-RING en NBR (FKM-EPDM-HNBR bajo demanda)		5 Vedação O-RING em NBR (FKM-EPDM-HNBR sob encomenda)	
6 Tige: laiton chromé		6 Eje en latón cromado		6 Eixo em Latão Cromado	
7 Poignée en PA66 chargé en fibre de verre		7 Maneta en PA66 con fibra de vidrio		7 Manopla em PA66 e fibra de vidro	
8 Plaquette de poignée: résine acétal		8 Plaqueta en PA6		8 Piaqueta de Resina Acetálica	
9 Vis: acier		9 Tornillo en acero		9 Parafuso em aço	
10 Bille: laiton chromé		10 Esfera en latón cromado		10 Esfera em Latão Cromado	
11 Joint torique NBR*		11 Junta tórica O-RING en NBR*		11 Vedação O-RING em NBR*	
12 Ecrou de blocage: laiton		12 Racor en latón		12 Conexões em Latão	



Temperature

Temperatures
Temperatur
Températures
Temperaturas
Temperaturas

- 20 °C
+ 80 °C

FKM
- 15 °C
+ 130 °C

EPDM
- 40 °C
+ 130 °C

HNBR
- 30 °C
+ 130 °C



Pressioni

Pressures
Druckbereich
Pressions
Presiones
Pressões

-0.99 bar (-0.099 MPa)
20 bar (2 MPa)

DIAGRAMMA PRESSIONE - TEMPERATURA

PRESSURE - TEMPERATURE RATINGS DIAGRAM
DRUCK - TEMPERATUR DIAGRAMM
DIAGRAMME PRESSION - TEMPÉRATURE
DIAGRAMA PRESIÓN-TEMPERATURA
DIAGRAMA DE PRESSÃO-TEMPERATURA

PTFE + FKM

PTFE + NBR

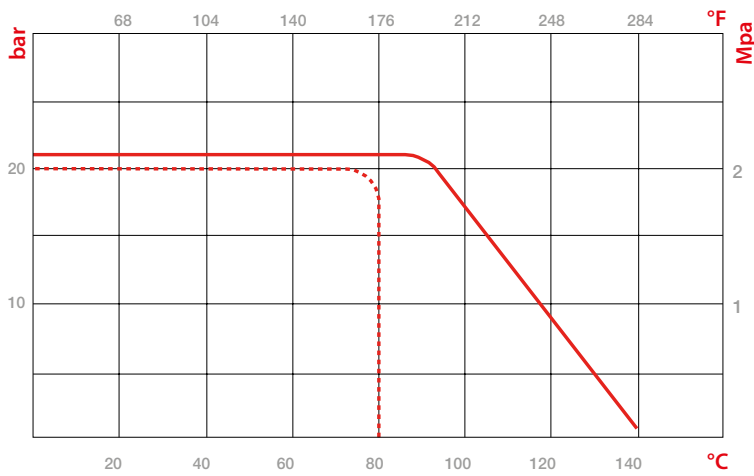

Fluidi compatibili

Aria compressa / Acqua / Oli

1ª e 2ª famiglia di gas a media pressione.
3ª famiglia di gas a bassa pressione.

Fluids

Compressed air / Water / Oils

1st and 2nd family gases at medium pressure.
3rd family gases at low pressure.

Geeignete Medien

Druckluft / Wasser / Öl

1. und 2. Familie von Gasen für Mitteldruck.
3. Familie von Gasen für Niederdruck.

Fluides compatibles

Air comprimé / Eau / Huile

Famille 1 et 2 des gaz à moyenne pression.
Famille 3 des gaz à basse pression.

Fluidos compatibles

Aire comprimido / Agua / Aceite

1ª y 2ª familia de gases a media presión.
3ª familia de gas a baja presión.

Fluidos compatíveis

Ar comprimido / Água / Óleos

1ª e 2ª família de gás a média pressão.
3ª família de gás a baixa pressão.



Filettatura

Gas conforme ISO 7.1, BS 21, DIN 2999
Gas cilindrica conforme ISO 228 Classe A.

Threads

Gas in conformity with ISO 7.1, BS 21, DIN 2999.
Parallel gas in conformity with ISO 228 Class A.

Gewindearten

Gewinde nach Norm ISO 7.1, BS 21, DIN 2999.
Zylindrisches Gewinde nach Norm ISO 228 Classe A.

Filetages

Filetage conforme: ISO 7.1, BS 21, DIN 2999.
Filetage cylindrique conforme: ISO 228 Class A.

Roscas

Gas conforme ISO 7.1, BS 21, DIN 2999
Gas cilíndrica conforme ISO 228 Clase A.

Roscas

Gas conforme ISO 7.1, BS 21, DIN 2999.
Gas paralela conforme ISO 228 Classe A.

CURVE CARATTERISTICHE DI FLUSSO PER ARIA RELATIVE ALLE VALVOLE A SFERA GHILUX ART. 6400 FEMMINA-FEMMINA

CHARACTERISTIC CURVES OF FLOW FOR AIR PERTINENT TO THE BALL VALVES GHILUX ART. 6400 FEMALE-FEMALE

DURCHFLUSSKENNLINIEN FÜR DRUCKLUFT ANGEGEBEN FÜR DIE KUGELHÄHNE GHILUX ART. 6400 INNEN-/INNENGEWINDE

DIAGRAMME DE VALEUR DU DEBIT POUR ROBINET GHILUX ART. 6400

CURVA CARACTERÍSTICA DE FLUJO PARA AIRE RELATIVO A LAS VÁLVULAS A ESFERA GHILUX ART.6400 HEMBRA-HEMBRA

CURVAS CARACTERÍSTICAS DE VAZÃO PARA AR RELATIVAS ÀS VÁLVULAS DE ESFERA GHILUX CÓD. 6400 FÊMEA-FÊMEA

NI/min

Portata
Flow rate
Durchfluss
Débit
Caudal
Vazão

P1 (bar)

Pressione di entrata
Inlet Pressure
Eingangsdruck
Pression d'entrée
Presión de entrada
Pressão de entrada

P2 (bar)

Pressione di uscita
Outlet Pressure
Ausgangsdruck
Pression de sortie
Presión de salida
Pressão de saída

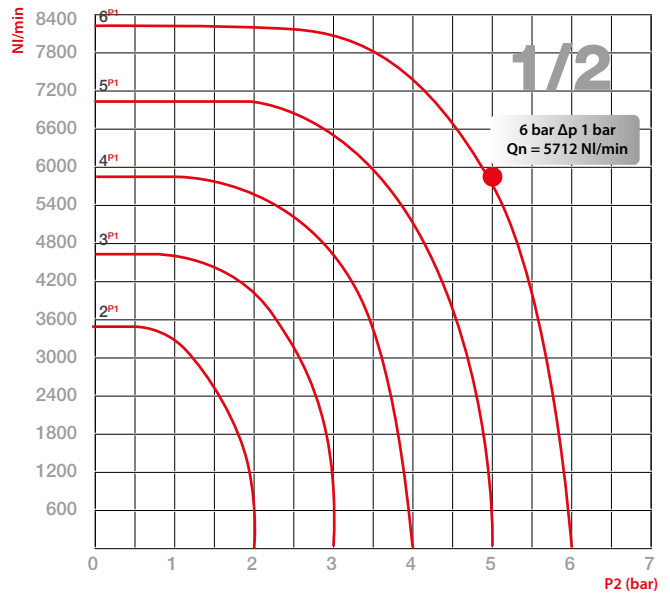
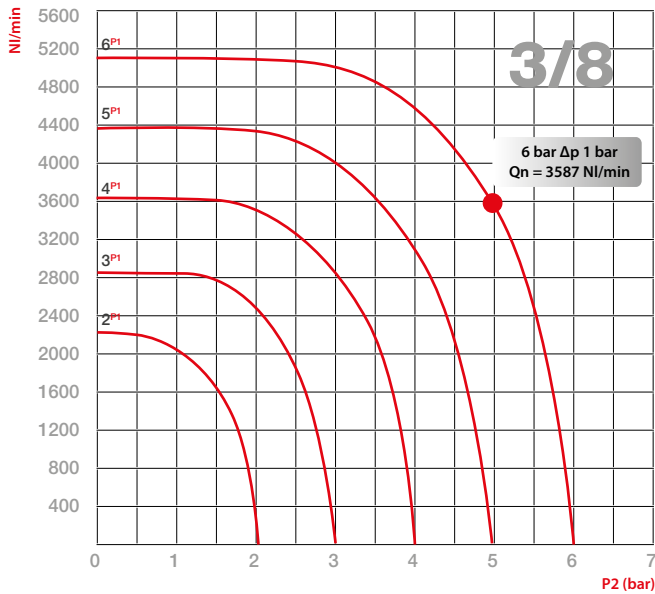
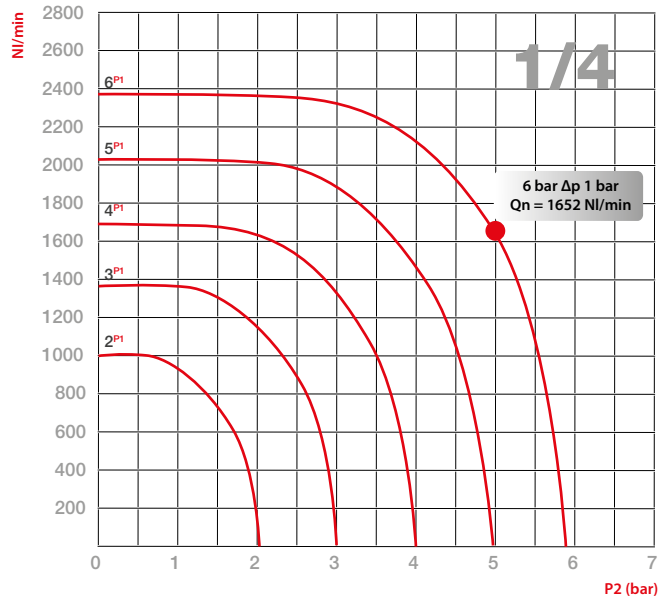
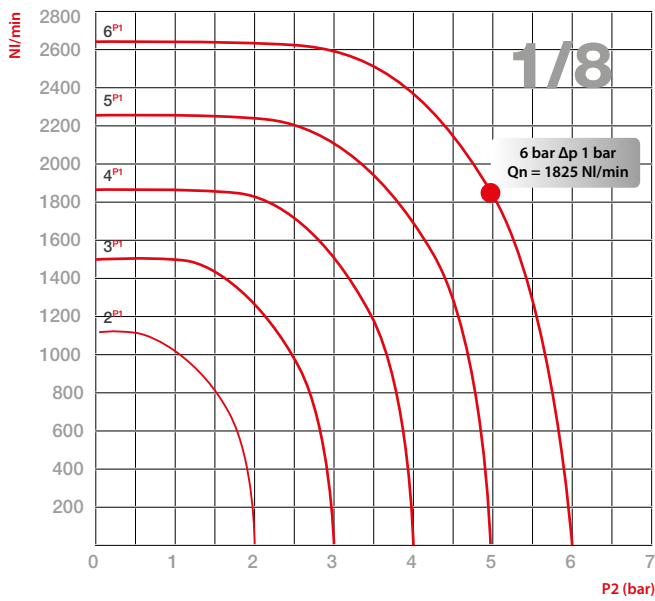



DIAGRAMMA DELLA CARATTERISTICA PORTATA-PERDITA DI CARICO RELATIVO ALLE VALVOLE A SFERA GHILUX ART. 6400 FEMMINA-FEMMINA PER ACQUA

DIAGRAM OF THE FLOW RATE AND PRESSURE DROP CHARACTERISTICS PERTINENT TO THE BALL VALVES GHILUX ART. 6400 FEMALE-FEMALE FOR WATER
 DURCHFLOSS- UND DRUCKABFALLDIAGRAMM FÜR WASSER ANGEZEIGT FÜR DIE KUGELHÄHNE GHILUX ART. 6400 INNEN-/INNENGEWINDE
 DIAGRAMME DEBIT ET PERTE DE CHARGE POUR ROBINET GHILUX ART. 6400 FEMELLE/FEMELLE
 DIAGRAMA DE LAS CARACTERÍSTICAS CAUDAL-PÉRDIDA DE CARGA RELATIVO A LAS VÁLVULAS A ESFERA ART.6400 HEMBRA-HEMBRA PARA AGUA
 DIAGRAMA DA CARACTERÍSTICA DE VAZÃO-PERDA DE CARGA RELATIVO ÀS VÁLVULAS DE ESFERA GHILUX CÓD. 6400 FÊMEA-FÊMEA PARA ÁGUA

ΔP (DAPA)

Perdita di carico
 Pressure drop
 Druckabfall
 Perte de charge
 Pérdida de carga
 Perda de carga

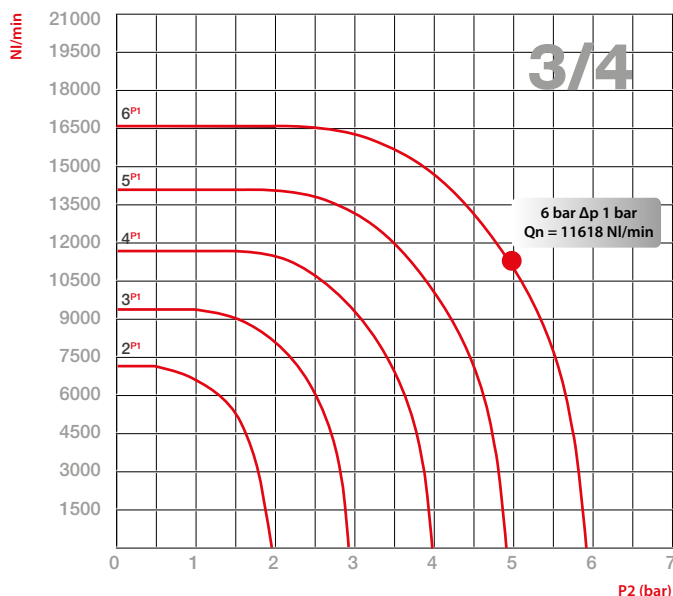
1 DAPA = 1,019 mm H₂O

Kv (Kg/h)

Portata
 Flow rate
 Durchfluss
 Débit
 Caudal
 Vazão

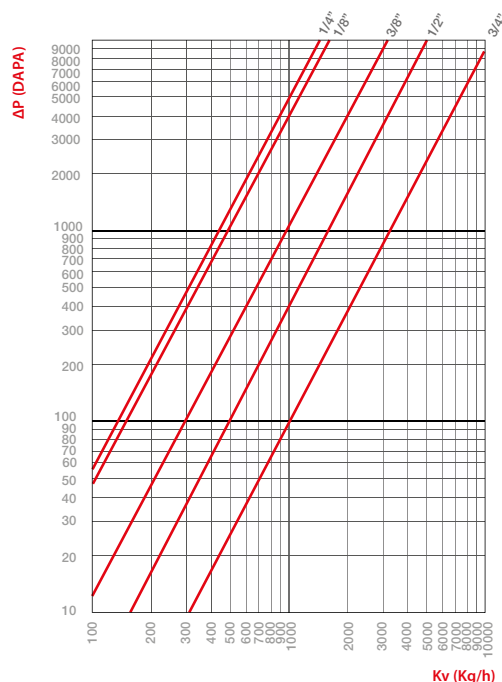

Misura Size Größe Dimension Medida Tamanho	Coefficiente di portata idraulica Factor of Hydraulic flow rate Hydraulische Durchflusskoeffizienten Coefficient du débit hydraulique Coeficiente de caudal hidráulico Coeficiente de vazão hidráulica
	Kv (Kg/h) m ³ /h
1/8"	1614 1,6
1/4"	1461 1,4
3/8"	3164 3,1
1/2"	5051 5
3/4"	10274 10,2

Coefficienti di Portata Kv

IT

Ripartiamo in tabella il coefficiente di portata **Kv** delle valvole a sfera GHILUX, ricordando che tale coefficiente rappresenta la quantità d'acqua che attraversa la valvola nell'unità di tempo (Kg/h) alla temperatura di 15,5° C e che determina una caduta di pressione unitaria.

Flow Rate Factors Kv

GB

On the following table we specify the flow rate factor **Kv** of the ball valves GHILUX, we remind You that this factor represent the quantity of water that cross the valve in the unit time (Kg/h) at the temperature of 15,5° C and it determines a drop of unitary pressure.

Durchflusskoeffizienten Kv

DE

Die folgende Tabelle zeigt den Durchflusskoeffizienten **Kv** der GHILUX Kugelhähne. Dieser Faktor steht für die Wassermenge, welche den Kugelhahn in der Zeiteinheit (Kg/h) bei einer Temperatur von ca. 15,5° C durchfließt und er bestimmt einen einheitlichen Druckabfall.

Coefficient de Débit Kv

FR

Les valeurs **Kv** mentionnées sous le tableau sont valables pour les robinets GHILUX. Nous rappelons que le coefficient **Kv** représente la quantité d'eau traversant le robinet dans l'unité de temps (Kg/h) à la température de 15,5°C déterminant une perte de charge unitaire.

Coefficientes de Caudal Kv

ES

Representamos en la tabla los coeficientes de caudal **Kv** de las válvulas a esfera serie GHILUX, recordando que este coeficiente representa la cantidad de agua que pasa por la válvula por unidad de tiempo (Kg/h) a la temperatura de 15,5° C y que determina una caída de presión unitaria.

Coefficientes de Vazão Kv

PT

Especificamos na tabela a seguir o coeficiente de vazão **Kv** das válvulas de esfera GHILUX, recordando que tal coeficiente representa a quantidade de água que atravessa a válvula na unidade de tempo (Kg/h) a uma temperatura de 15,5° C e que determina uma queda de pressão unitária.



Opzioni

Option

Optionen

Options

Opciones

Opções

CODICE ARTICOLO
ARTICLE CODE
ARTIKEL-NUMMER
CODE ARTICLE
CÓDIGO ARTÍCULO
CÓDIGO DO PRODUTO

MISURA
SIZE
GRÖSSE
DIMENSIONS
MEDIDA
TAMANHO

COLORE PIASTRINA
COLOUR OF THE PLATE
GRIFFPLATTEN FARBEN
COULEUR DE LA PLAQUETTE
COLOR PLAQUETA
COR PLAQUETA

TIPO DI GUARNIZIONE
TYPE OF THE SEAL
ART DER DICHTUNG
TYPE DE JOINT
TIPO DE JUNTA
TIPO DE VEDAÇÃO

TIPO MANIGLIA
TYPE OF HANDLES
ART DES HANDGRIFFES
TYPE DE POIGNÉE
TIPO DE MANETA
TIPO DE MANETA

TIPO DI OGIVA
TYPE OF OLIVE
ART DES KLEMMRINGES
TYPE DE BAGUE
TIPO DE BICONO
TIPO DE BUCHA

6430

3/8-3/8

RED PLATE

NBR

BRASS Olive



Piastrina Rossa
Red Plate
Griffplatte Rot
Plaquette Rouges
Plaqueta Roja
Plaqueta Vermelha

NBR



Maniglia CORTA STANDARD per valvola da 1/8 - 1/4 - 3/8 - 1/2
Maniglia LUNGA STANDARD per Valvola da 3/4

Standard SHORT Handle for Valve 1/8-1/4-3/8-1/2
Standard LONG Handle for Valve 3/4

Handgriff KURZ Standard für 1/8-1/4-3/8-1/2
Handgriff LANG Standard für 3/4

Poignée COURTE en standard pour 1/8-1/4-3/8-1/2
Poignée LONGUE en standard pour 3/4

Maneta CORTA estándar para válvula de 1/8-1/4-3/8-1/2
Maneta LARGA estándar para válvula de 3/4

Manopla CURTA standard para válvula de 1/8-1/4-3/8-1/2
Manopla LONGA standard para válvula de 3/4



Ogiva OTTONE
Brass OLIVE
Klemmring MESSING
Bague LAITON
Bicono LATÓN
Bucha em LATÃO

Su richiesta
If required
Auf Anfrage
Sur demande
Bajo demanda
Sob encomenda



Piastrina Blu
Blue Plate
Griffplatte Blau
Plaquette Bleu
Plaqueta Azul
Plaqueta Azul



Piastrina Verde
Green Plate
Griffplatte Grün
Plaquette Verte
Plaqueta Verde
Plaqueta Verde



Piastrina Bianca
White Plate
Griffplatte Weiss
Plaquette Blanche
Plaqueta Blanca
Plaqueta Branca



Piastrina Gialla
Yellow Plate
Griffplatte Gelb
Plaquette Jaune
Plaqueta Amarela
Plaqueta Amarela

GAS:



Piastrina Gialla EN 331
Yellow Plate EN 331
Griffplatte Gelb EN 331
Plaquette Jaune EN 331
Plaqueta Amarilla EN 331
Plaqueta Amarela EN 331

**FKM
HNBR
EPDM**



Maniglia LUNGA
LONG Handle
Handgriff LANG
Poignée LONGUE
Maneta LARGA
Manopla LONGA



Ogiva PTFE
PTFE Olive
Klemmring PTFE
Bague PTFE
Bicono PTFE
Bucha em PTFE

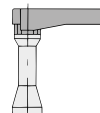

Maniglia LUNGA con Prolunga albero di comando

Long HANDLE with Spindle Extension
Handgriff LANG mit verlängerter Schaltwelle

Poignée LONGUE avec arbre rallongé

Maneta LARGA prolongada
Manopla LONGA com Prolongamento no eixo de comando

6300

VALVOLA FEMMINA RP ISO 7 - FEMMINA RP ISO 7

FEMALE RP ISO 7 - FEMALE RP ISO 7 VALVE
 KUGELHAHN INNENGEW. RP ISO 7 - INNENGEW. RP ISO 7
 ROBINET - TARAUDAGE RP ISO 7
 VÁLVULA HEMBRA RP ISO 7 - HEMBRA RP ISO 7
 VÁLVULA ROSCA FÊMEA RP ISO 7 - ROSCA FÊMEA RP ISO 7

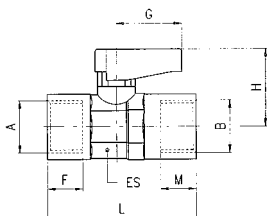

Code	A	B	DN	ES	F	M	L	G	H	Pack.
06300 00 001	1/8	1/8	6	14-15	7.4	7.4	36	19	21	10
06300 00 002	1/4	1/4	6	14-15	11	11	43	19	21	10
06300 00 003	3/8	3/8	8	18-19	11.4	11.4	47	19	22	10
06300 00 004	1/2	1/2	10	22-23	15	15	59	26	30.5	10
06300 00 055	3/4	3/4	14	28-30	16.3	16.3	67	50	33	5

6310

VALVOLA MASCHIO CONICO R ISO 7 - FEMMINA RP ISO 7

TAPER MALE R ISO 7 - FEMALE RP ISO 7 VALVE
 KUGELHAHN AUSSENGEW. KONISCH R ISO 7 - INNENGEW. RP ISO 7
 ROBINET FILETAGE R ISO 7 - TARAUDAGE RP ISO 7
 VÁLVULA MACHO CÓNICO R ISO 7 - HEMBRA RP ISO 7
 VÁLVULA ROSCA MACHO CÔNICA R ISO 7 - ROSCA FÊMEA RP ISO 7

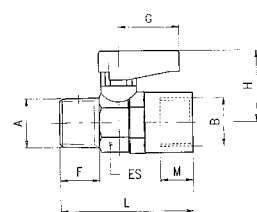

Code	A	B	DN	ES	F	M	L	G	H	Pack.
06310 00 001	1/8	1/8	6	14-15	7.4	7.4	36	19	21	10
06310 00 002	1/4	1/8	6	14-15	11	7.4	40.5	19	21	10
06310 00 003	1/4	1/4	6	14-15	11	11	43	19	21	10
06310 00 004	3/8	3/8	8	18-19	11.4	11.4	46	19	22	10
06310 00 005	1/2	1/2	10	22-23	15	15	57	26	30.5	10
06310 00 066	3/4	3/4	14	28-30	16.3	16.3	63	50	33	5

6320

VALVOLA MASCHIO CILINDRICO GA ISO 228 - FEMMINA RP ISO 7

PARALLEL MALE GA ISO 228 - FEMALE RP ISO 7 VALVE
 KUGELHAHN AUSSENGEW. ZYLINDRISCH GA ISO 228 - INNENGEW. RP ISO 7
 ROBINET FILETAGE GA ISO 228 - TARAUDAGE RP ISO 7
 VÁLVULA MACHO CILÍNDRICO GA ISO 228 - HEMBRA RP ISO 7
 VÁLVULA ROSCA MACHO PARALELA GA ISO 228 - FÊMEA RP ISO 7

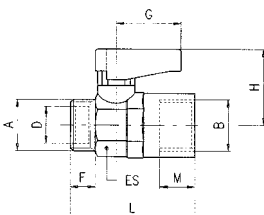

Code	A	B	DN	ES	D	F	M	L	G	H	Pack.
06320 00 001	1/8	1/8	6	14-15	6.2	7	7.4	34.5	19	21	10
06320 00 002	1/4	1/8	6	14-15	8.2	8	7.4	35.5	19	21	10
06320 00 003	1/4	1/4	6	14-15	8.2	8	11	38	19	21	10
06320 00 004	3/8	3/8	8	18-19	10.2	9	11.4	41.5	19	22	10
06320 00 005	1/2	1/2	10	22-23	15.2	10	15	50	26	30.5	10
06320 00 066	3/4	3/4	14	28-30	18.2	12	16.3	56.5	50	33	5

6330

VALVOLA MASCHIO CONICO R ISO 7 - MASCHIO CILINDRICO GA ISO 228

TAPER MALE R ISO 7 - PARALLEL MALE GA ISO 228 VALVE
 KUGELHAHN AUSSENGEW. KONISCH R ISO 7 - AUSSENGEW. ZYLINDRISCH GA ISO 228
 ROBINET FILETAGE R ISO 7 - FILETAGE GA ISO 228
 VÁLVULA MACHO CÓNICO R ISO 7 - MACHO CILÍNDRICO GA ISO 228
 VÁLVULA ROSCA MACHO CÔNICA R ISO 7 - ROSCA MACHO PARALELA GA ISO 228

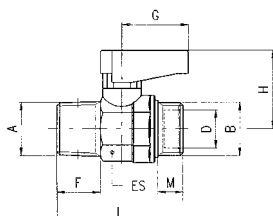

Code	A	B	DN	ES	D	F	M	L	G	H	Pack.
06330 00 001	1/8	1/8	6	14-15	6.2	7.4	7	33.5	19	21	10
06330 00 002	1/8	1/4	6	14-15	8.2	7.4	8	33.5	19	21	10
06330 00 003	1/4	1/8	6	14-15	6.2	11	7	38	19	21	10
06330 00 004	1/4	1/4	6	14-15	8.2	11	8	38	19	21	10
06330 00 005	3/8	3/8	8	18-19	10.2	11.4	9	41.5	19	22	10
06330 00 006	1/2	1/2	10	22-23	15.2	15	10	49	26	30.5	10
06330 00 077	3/4	3/4	14	28-30	18.2	16.3	12	55.5	50	33	5

6340

VALVOLA TUBO - FEMMINA RP ISO 7

TUBE - FEMALE RP ISO 7 VALVE
 KUGELHAHN ROHR - INNENGEW. G ISO 228
 ROBINET TUBE - TARAUDAGE RP ISO 7
 VÁLVULA TUBO - HEMBRA RP ISO 7
 VÁLVULA TUBO - ROSCA FÊMEA RP ISO 7

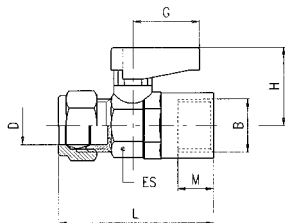

Code	D	B	DN	ES	M	L	G	H	Pack.
06340 00 001	6	1/8	6	14-15	7.4	41.5	19	21	10
06340 00 002	8	1/8	6	14-15	7.4	43	19	21	10
06340 00 003	8	1/4	6	14-15	11	46	19	21	10
06340 00 004	10	3/8	8	18-19	11.4	50.5	19	22	10
06340 00 005	12	3/8	8	18-19	11.4	51.5	19	22	10
06340 00 006	14	1/2	10	22-23	15	61.5	26	30.5	10
06340 00 007	15	1/2	10	22-23	15	61.5	26	30.5	10
06340 00 098	16	3/4	14	28-30	16.3	68	50	33	5
06340 00 099	18	3/4	14	28-30	16.3	68	50	33	5

6350

VALVOLA MASCHIO CONICO R ISO 7 - TUBO

TAPER MALE R ISO 7 - TUBE VALVE
 KUGELHAHN AUSSENGEW. KONISCH R ISO 7 - ROHR
 ROBINET FILETAGE R ISO 7 - TUBE
 VÁLVULA MACHO CÓNICO R ISO 7 - TUBO
 VÁLVULA ROSCA MACHO CÓNICA R ISO 7 - TUBO

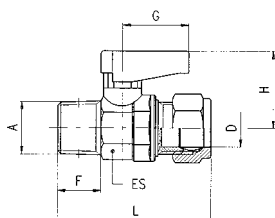

Code	A	D	DN	ES	F	L	G	H	Pack.
06350 00 001	1/8	6	6	14-15	7.4	40.5	19	21	10
06350 00 002	1/8	8	6	14-15	7.4	41.5	19	21	10
06350 00 003	1/4	6	6	14-15	1.1	46	19	21	10
06350 00 004	1/4	8	6	14-15	1.1	45	19	21	10
06350 00 005	3/8	10	8	18-19	1.4	50.5	19	22	10
06350 00 006	3/8	12	8	18-19	1.4	51.5	19	22	10
06350 00 007	1/2	14	10	22-23	1.5	59.5	26	30.5	10
06350 00 008	1/2	15	10	22-23	1.5	59.5	26	30.5	10
06350 00 109	3/4	16	14	28-30	16.3	67	50	33	5
06350 00 110	3/4	18	14	28-30	16.3	67	50	33	5

6400

VALVOLA FEMMINA G ISO 228 - FEMMINA G ISO 228

FEMALE G ISO 228 - FEMALE G ISO 228 VALVE
 KUGELHAHN INNENGEW. G ISO 228 - INNENGEW. G ISO 228
 ROBINET TARAUDAGE G ISO 228
 VÁLVULA HEMBRA G ISO 228 - HEMBRA G ISO 228
 VÁLVULA ROSCA FÊMEA G ISO 228 - ROSCA FÊMEA G ISO 228

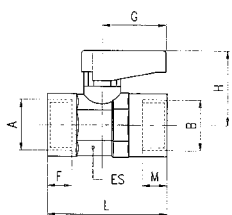

Code	A	B	DN	ES	F	M	L	G	H	Pack.
06400 00 001	1/8	1/8	6	14-15	7	7	35	19	21	10
06400 00 002	1/4	1/4	6	14-15	8	8	37	19	21	10
06400 00 003	3/8	3/8	8	18-19	9	9	42	19	22	10
06400 00 004	1/2	1/2	10	22-23	10	10	49	26	30.5	10
06400 00 055	3/4	3/4	14	28-30	12	12	58	50	33	5

6410

VALVOLA MASCHIO CILINDRICO GA ISO 228 - FEMMINA G ISO 228

PARALLEL MALE GA ISO 228 - FEMALE G ISO 228 VALVE
 KUGELHAHN AUSSENGEW. ZYLINDRISCH GA ISO 228 - INNENGEW. G ISO 228
 ROBINET FILETAGE GA ISO 228 - TARAUDAGE G ISO 228
 VÁLVULA MACHO CILÍNDRICO GA ISO 228 - HEMBRA G ISO 228
 VÁLVULA ROSCA MACHO PARALELA GA ISO 228 - ROSCA FÊMEA G ISO 228

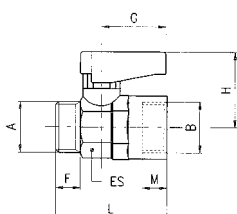

Code	A	B	DN	ES	F	M	L	G	H	Pack.
06410 00 001	1/8	1/8	6	14-15	7	7	34	19	21	10
06410 00 002	1/4	1/8	6	14-15	8	7	35	19	21	10
06410 00 003	1/4	1/4	6	14-15	8	8	35	19	21	10
06410 00 004	3/8	3/8	8	18-19	9	9	39	19	22	10
06410 00 005	1/2	1/2	10	22-23	10	10	45	26	30.5	10
06410 00 066	3/4	3/4	14	28-30	12	12	52	50	33	5

6420

VALVOLA MASCHIO CILINDRICO GA ISO 228 - MASCHIO CILINDRICO GA ISO 228
 PARALLEL MALE GA ISO 228 - PARALLEL MALE GA ISO 228 VALVE
 KUGELHAHN AUSSERGEW. ZYLINDRISCH GA ISO 228 - AUSSERGEW. ZYLINDRISCH GA ISO 228
 ROBINET FILETAGE GA ISO 228
 VÁLVULA MACHO CILÍNDRICO GA ISO 228 - MACHO CILÍNDRICO GA ISO 228
 VÁLVULA ROSCA MACHO PARALELA GA ISO 228 - ROSCA MACHO PARALELA GA ISO 228

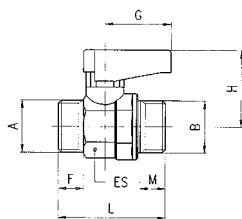

Code	A	B	DN	ES	F	M	L	G	H	Pack.
06420 00 001	1/8	1/8	6	14-15	7	7	32	19	21	10
06420 00 002	1/8	1/4	6	14-15	7	8	32	19	21	10
06420 00 003	1/4	1/4	6	14-15	8	8	33	19	21	10
06420 00 004	3/8	1/4	6	14-15	9	8	33	19	21	10
06420 00 005	3/8	3/8	8	18-19	9	9	37	19	22	10
06420 00 006	1/2	3/8	8	18-19	10	9	37	19	22	10
06420 00 007	1/2	1/2	10	22-23	10	10	42	26	30.5	10
06420 00 008	3/4	1/2	10	22-23	12	10	42	50	30.5	10
06420 00 099	3/4	3/4	14	28-30	12	12	49	50	33	5

6430

VALVOLA TUBO - FEMMINA G ISO 228
 TUBE - FEMALE G ISO 228 VALVE
 KUGELHAHN ROHR - INNENGEW. G ISO 228
 ROBINET TUBE - TARAUDAGE GA ISO 228
 VÁLVULA TUBO - HEMBRA G ISO 228
 VÁLVULA TUBO - ROSCA FÊMEA G ISO 228

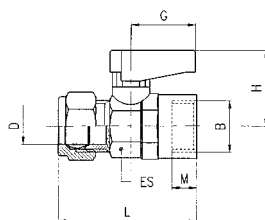

Code	D	B	DN	ES	M	L	G	H	Pack.
06430 00 001	6	1/8	6	14-15	7	41	19	21	10
06430 00 002	8	1/8	6	14-15	7	43	19	21	10
06430 00 003	8	1/4	6	14-15	8	43	19	21	10
06430 00 004	10	3/8	8	18-19	9	48	19	22	10
06430 00 005	12	3/8	8	18-19	9	49	19	22	10
06430 00 006	14	1/2	10	22-23	10	55.5	26	30.5	10
06430 00 007	15	1/2	10	22-23	10	55.5	26	30.5	10
06430 00 098	16	3/4	14	28-30	12	63.5	50	33	5
06430 00 099	18	3/4	14	28-30	12	63.5	50	33	5

6440

VALVOLA MASCHIO CILINDRICO GA ISO 228 - TUBO
 PARALLEL MALE GA ISO 228 - TUBE VALVE
 KUGELHAHN AUSSERGEW. ZYLINDRISCH GA ISO 228 - ROHR
 ROBINET FILETAGE GA ISO 228 - TUBE
 VÁLVULA MACHO CILÍNDRICO GA ISO 228 - TUBO
 VÁLVULA ROSCA MACHO PARALELA GA ISO 228 - TUBO

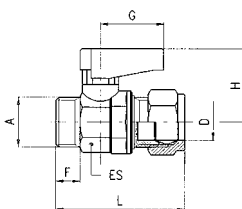

Code	A	D	DN	ES	F	L	G	H	Pack.
06440 00 001	1/8	6	6	14-15	7	39	19	21	10
06440 00 002	1/8	8	6	14-15	7	40	19	21	10
06440 00 003	1/4	6	6	14-15	8	40	19	21	10
06440 00 004	1/4	8	6	14-15	8	41	19	21	10
06440 00 005	1/4	10	6	14-15	8	44	19	21	10
06440 00 006	3/8	8	6	14-15	9	43	19	21	10
06440 00 007	3/8	10	8	18-19	9	46	19	22	10
06440 00 008	3/8	12	8	18-19	9	47	19	22	10
06440 00 009	3/8	14	8	18-19	9	50.5	19	22	10
06440 00 010	3/8	15	8	18-19	9	50.5	19	22	10
06440 00 011	1/2	10	8	18-19	10	49	19	22	10
06440 00 012	1/2	12	8	18-19	10	50	19	22	10
06440 00 013	1/2	14	10	22-23	10	52.5	26	30.5	10
06440 00 014	1/2	15	10	22-23	10	52.5	26	30.5	10
06440 00 015	3/4	14	10	22-23	12	56.5	26	30.5	10
06440 00 016	3/4	15	10	22-23	12	56.5	26	30.5	10
06440 00 197	3/4	16	14	28-30	12	60.5	50	33	5
06440 00 198	3/4	18	14	28-30	12	60.5	50	33	5

Nelle misure 1/4-8, 1/4-10, 3/8-14, 3/8-15 il dado, il bicono e il filetto A sono all'opposto della figura.
 In the sizes 1/4-8, 1/4-10, 3/8-14, 3/8-15 the nut, the double cone and the thread A are at the opposite side of the picture.

In den Größen 1/4-8, 1/4-10, 3/8-14, 3/8-15 sind die Überwurfmutter mit dem Klemmring und das Gewinde A auf der gegenüberliegenden Seite des Bildes.

Pour les dimensions 1/4-8, 1/4-10, 3/8-14, 3/8-15, le filetage A et le raccord sont inversés par rapport à l'image.

En las medidas 1/4-8, 1/4-10, 3/8-14, 3/8-15 la tuerca, el bicono y la rosca A son opuestos a la figura.
 Nos tamanhos 1/4-8, 1/4-10, 3/8-14, 3/8-15 a porca, o cone duplo e a rosca A são do lado oposto ao mostrado na foto.

6450

VALVOLA TUBO - TUBO

TUBE - TUBE VALVE
KUGELHAHN ROHR - ROHR
ROBINET TUBE - TUBE
VÁLVULA TUBO - TUBO
VÁLVULA TUBO - TUBO

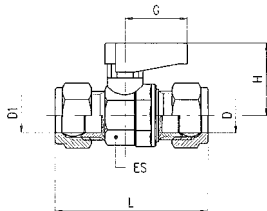

Code	D1	D	DN	ES	L	G	H	Pack.
06450 00 001	6	6	6	14-15	46	19	21	10
06450 00 002	6	8	6	14-15	48	19	21	10
06450 00 003	8	8	6	14-15	48	19	21	10
06450 00 004	10	8	6	14-15	51	19	21	10
06450 00 005	10	10	8	18-19	55	19	22	10
06450 00 006	10	12	8	18-19	56	19	22	10
06450 00 007	12	12	8	18-19	57	19	22	10
06450 00 008	14	10	8	18-19	59.5	19	22	10
06450 00 009	14	12	8	18-19	60.5	19	22	10
06450 00 010	15	10	8	18-19	59.5	19	22	10
06450 00 011	15	12	8	18-19	60.5	19	22	10
06450 00 012	14	14	10	22-23	63	26	30.5	10
06450 00 013	15	14	10	22-23	63	26	30.5	10
06450 00 014	15	15	10	22-23	63	26	30.5	10
06450 00 015	16	14	10	22-23	68	26	30.5	10
06450 00 016	16	15	10	22-23	68	26	30.5	10
06450 00 017	18	14	10	22-23	68	26	30.5	10
06450 00 018	18	15	10	22-23	68	26	30.5	10
06450 00 219	18	16	14	28-30	71	50	33	5
06450 00 220	18	18	14	28-30	71	50	33	5

6460

No Gas

VALVOLA DADO CAPETTATO - MASCHIO CONICO R ISO 7

MILLED NUT - TAPER MALE R ISO 7 VALVE
KUGELHAHN RÄNDELMUTTER - AUSSENGEW. KONISCH R ISO 7
ROBINET ECROU MOLETÉ - FILETAGE R ISO 7
VÁLVULA TUERCA - MACHO CÓNICO R ISO 7
VÁLVULA PORCA RECARTEILHADA - ROSCA MACHO CÓNICA R ISO 7

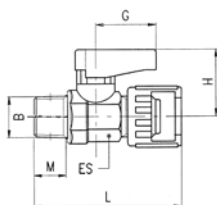

Code	B	DN	ES	M	L	G	H	Pack.
06460 00 001	1/8	6	14-15	7.4	44	19	21	10
06460 00 002	1/4	6	14-15	11	49.5	19	21	10
06460 00 003	3/8	8	18-19	11.4	50	19	21	10

6470

No Gas

VALVOLA DADO CAPETTATO - FEMMINA G ISO 228

MILLED NUT - FEMALE G ISO 228 VALVE
KUGELHAHN RÄNDELMUTTER - INNENGEW. G ISO 228
ROBINET ECROU MOLETÉ - TARAUDAGE G ISO 228
VÁLVULA TUERCA - HEMBRA G ISO 228
VÁLVULA PORCA RECARTEILHADA - ROSCA FÊMEA G ISO 228

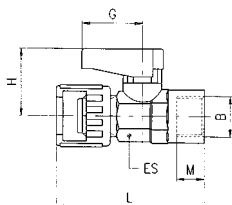

Code	B	DN	ES	M	L	G	H	Pack.
06470 00 001	1/8	6	14-15	7	46	19	21	10
06470 00 002	1/4	6	14-15	8	46	19	21	10

6490

VALVOLA CON PIEDINI D'ANCORAGGIO FEMMINA-FEMMINA

FOOT MOUNTED FEMALE-FEMALE VALVE
 KUGELHAHN MIT INNENGEWINDE UND BEFESTIGUNGSBÜGEL
 ROBINET - TARAUDAGE, PLAQUE DE FIXATION
 VÁLVULA CON PIE DE ANCLAJE HEMBRA-HEMBRA
 VÁLVULA COM PÉS DE FIXAÇÃO ROSCA FÊMEA-FÊMEA

Code	A	B	DN	ES	L	F	M	G	H	H1	P	Pack.
06490 00 002	1/4	1/4	6	14-15	43,5	8	8	19	21	31,5	30	10
06490 00 003	3/8	3/8	8	18-19	44	9	9	19	22	38	32	10

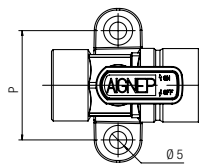
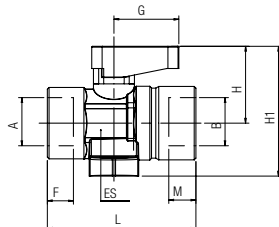

6500

VALVOLA CON PIEDINI D'ANCORAGGIO TUBO-TUBO

FOOT MOUNTED TUBE-TUBE VALVE
 KUGELHAHN MIT BEFESTIGUNGSFLANSCH ROHR-ROHR
 ROBINET TUBE - TUBE, PLAQUE DE FIXATION
 VÁLVULA CON PIE DE ANCLAJE TUBO-TUBO
 VÁLVULA COM PÉS DE FIXAÇÃO TUBO-TUBO

Code	D	D1	DN	ES	L	H	H1	G	P	Pack.
06500 00 001	8	8	6	14-15	50	21	32	19	30	10

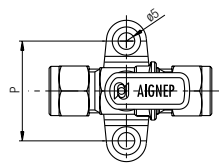
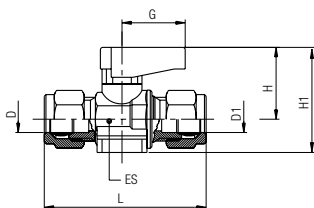

6540

VALVOLA A L MASCHIO CILINDRICO GA ISO 228-MASCHIO CONICO R ISO 7

ELBOW PARALLEL MALE GA ISO 228-TAPER MALE R ISO 7 VALVE
 WINKELKUGELHAHN AUSSENGEW. ZYLINDRISCH GA ISO 228 - AUSSENGEW. KONISCH R ISO 7
 ROBINET EN EQUERRE, FILETAGE R ISO 7 - FILETAGE GA ISO 228
 VÁLVULA A L MACHO CILÍNDRICO GA ISO 228 - MACHO CÓNICO R ISO 7
 VÁLVULA EM "L" ROSCA MACHO PARALELA GA ISO 228-ROSCA MACHO CÔNICA R ISO 7

Code	A	B	DN	ES	ES1	L	H	H1	G	Pack.
06540 00 001	1/4	1/4	6	14-15	17	48	21	17	19	10

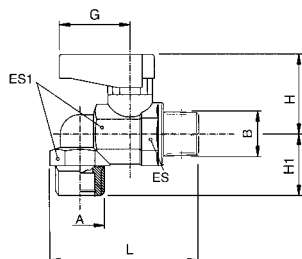

6560

No Gas

VALVOLA CON ATTACCHI TUBO AUTOMATICI

PUSH-IN CONNECTIONS VALVE

KUGELHAHN MIT STECKANSCHLUSS ROHR - ROHR

ROBINET, RACCORD INSTANTANÉ

VÁLVULA PARA TUBO AUTOMÁTICO

VÁLVULA COM ENGATE RÁPIDO PARA TUBO

Code	Tube	Tube	DN	ES	L	G	H	Pack.
06560 00 001	4	4	3	14-15	44	19	21	10
06560 00 002	6	6	5	14-15	48	19	21	10
06560 00 003	8	8	6	14-15	48	19	21	10
06560 00 075	10	10	8	18-19	58.5	19	22	10
06560 00 076	12	12	10	22-23	66	26	30.5	10

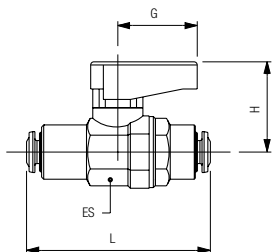

6570

No Gas

VALVOLA MASCHIO CONICO R ISO 7 - ATTACCO TUBO AUTOMATICO

TAPER MALE R ISO 7 - PUSH-FIT CONNECTIONS VALVE

KUGELHAHN AUSSEGEW. KONISCH R ISO 7 - ROHR STECKANSCHLUSS

ROBINET TARAUDAGE R ISO 7 - RACCORD INSTANTANÉ

VÁLVULA A ESFERA MACHO - TUBO AUTOMÁTICO

VÁLVULA ROSCA MACHO CÓNICA R ISO 7 - ENGATE RÁPIDO PARA TUBO

Code	A	Tube	DN	F	ES	L	C	H	Pack.
06570 00 001	1/8	4	3	8.5	14-15	35	19	21	10
06570 00 002	1/8	6	5	8.5	14-15	40	19	21	10
06570 00 004	1/8	8	6	8.5	14-15	41.5	19	21	10
06570 00 003	1/4	6	5	12.5	14-15	38.5	19	21	10
06570 00 005	1/4	8	6	12.5	14-15	45.5	19	22	10

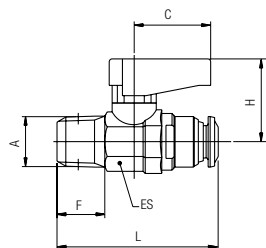

6600

No Gas

VALVOLA CON FORO DI SFIATO FEMMINA G ISO 228

EXHAUST HOLE FEMALE G ISO 228 - FEMALE G ISO 228 VALVE

KUGELHAHN MIT ENTLÜFTUNGSBOHRUNG INNENGEW. G ISO 228

ROBINET AVEC PURGE - TARAUDAGE G ISO 228

VÁLVULA HEMBRA ISO 228 CON ESCAPE ATMÓSFERA

VÁLVULA COM FURO DE ESCAPE E ROSCA FÊMEA G ISO 228

Code	A	B	DN	ES	F	M	L	G	H	S	Pack.
06600 00 001	1/8	1/8	6	14-15	7	7	35	19	21	2.5	10
06600 00 002	1/4	1/4	6	14-15	8	8	37	19	21	2.5	10
06600 00 003	3/8	3/8	8	18-19	9	9	42	19	22	3	10

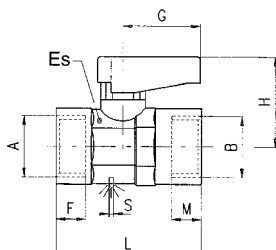

OPEN



CLOSE



86300

VALVOLA FEMMINA NPTF - FEMMINA NPTF

NPTF FEMALE - NPTF FEMALE VALVE

KUGELHAHN INNENGEW. NPTF - INNENGEW. NPTF

ROBINET - TARAUDAGE NPTF

VÁLVULA HEMBRA NPTF - HEMBRA NPTF

VÁLVULA ROSCA FÊMEA NPTF - ROSCA FÊMEA NPTF



Code	A	B	DN	ES	L	G	H	Pack.
86300 00 001	1/8	1/8	6	14-15	37,5	19	21	10
86300 00 002	1/4	1/4	6	14-15	46	19	21	10
86300 00 003	3/8	3/8	8	18-19	48,5	19	22	10
86300 00 004	1/2	1/2	10	22-23	62	26	30,5	10

86310

VALVOLA MASCHIO NPTF - FEMMINA NPTF

TAPER NPTF MALE - NPTF FEMALE VALVE

KUGELHAHN AUSSENGEW. NPTF KONISCH - INNENGEW. NPTF

ROBINET FILETAGE NPTF - TARAUDAGE NPTF

VÁLVULA MACHO NPTF - HEMBRA NPTF

VÁLVULA ROSCA MACHO NPTF - ROSCA FÊMEA NPTF



Code	A	B	DN	ES	F	L	G	H	Pack.
86310 00 001	1/8	1/8	6	14-15	8,5	37,5	19	21	10
86310 00 002	1/4	1/4	6	14-15	13	46	19	21	10
86310 00 003	3/8	3/8	8	18-19	13	48,5	19	22	10
86310 00 004	1/2	1/2	10	22-23	17	62	26	30,5	10

SERIE GHINOX

MINIVALVOLE A SFERA IN ACCIAIO INOX AISI 316 L
 MINIBALLVALVE IN STAINLESS STEEL AISI 316 L
 KUGELHÄHNE AISI 316 L
 MINI ROBINET A BOISSEAU SPHERIQUE EN ACIER INOXYDABLE AISI 316L
 MINI VÁLVULAS A ESFERA EN ACERO INOX AISI 316L
 MINI VÁLVULAS DE ESFERA EM AÇO-INOX AISI 316L



CARATTERISTICHE TECNICHE

TECHNICAL CHARACTERISTICS
 TECHNISCHE ANGABEN
 CARACTÉRISTIQUES TECHNIQUES
 CARACTERÍSTICAS TÉCNICAS
 CARACTERÍSTICAS TÉCNICAS



Norma di Riferimento

Reference standard

Entspricht der Norm

Norme de référence

Normativa de referencia

Norma de referência

1907/2006



2011/65/CE



NSF/ANSI 169



PED

2014/68/UE

SILICON

FREE

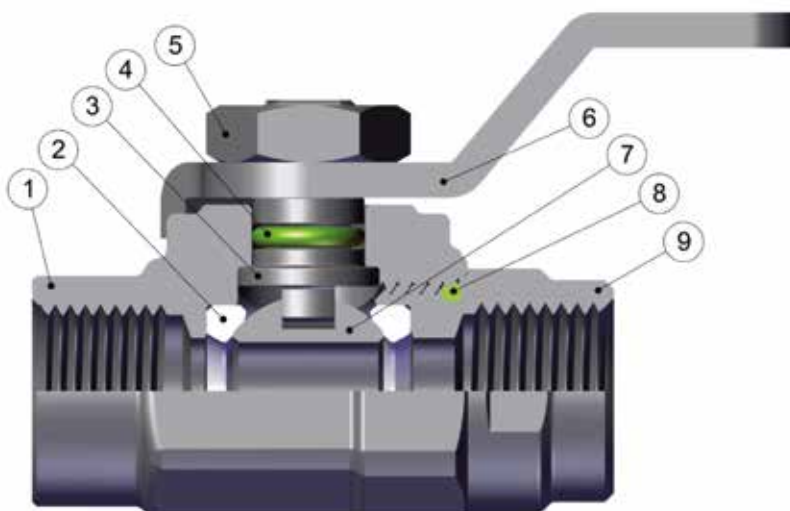

Materiali e Componenti

IT

- 1 Corpo in acciaio inox AISI 316L
- 2 Guarnizione sede sfera in PTFE
- 3 Albero in acciaio inox AISI316L
- 4 Guarnizione O-RING in FKM
- 5 Dado esagonale in acciaio inox AISI316L
- 6 Leva di comando in acciaio inox AISI316L
- 7 Sfera in acciaio inox AISI316L
- 8 Guarnizione O-RING in FKM
- 9 Raccordo in acciaio inox AISI316L

Component Parts and Materials

GB

- 1 Stainless steel AISI 316L Body
- 2 PTFE Seats
- 3 Stainless steel AISI316L Spindle
- 4 FKM Seal O-RING
- 5 Stainless steel AISI316L Hex Nut
- 6 Stainless steel AISI316L Spindle
- 7 Stainless steel AISI316L Ball
- 8 FKM Seal O-RING
- 9 Stainless steel AISI316L Fitting

Komponenten und Materialien

DE

- 1 Körper inox AISI 316L
- 2 Kugelsitzdichtung PTFE
- 3 Spindel inox AISI316L
- 4 O-RING FKM
- 5 Mutter inox AISI316L
- 6 Handgriff inox AISI316L
- 7 Kugel inox AISI316L
- 8 O-RING FKM
- 9 Gewindeinsatz inox AISI316L

Matériaux et Composants

FR

- 1 Corps: acier inoxydable AISI 316L
- 2 Joint bille sphérique PTFE
- 3 Tige: acier inoxydable AISI316L
- 4 Joint tige: FKM
- 5 Ecrou: acier inoxydable AISI316L
- 6 Poignée: acier inoxydable AISI316L
- 7 Bille: acier inoxydable AISI316L
- 8 Joint tige: FKM
- 9 Corps: acier inoxydable AISI316L

Materiales y Componentes

ES

- 1 Cuerpo en acero inox AISI 316L
- 2 Junta sede esfera en PTFE
- 3 Eje en acero inox AISI316L
- 4 Junta tórica en FKM
- 5 Tuerca hexagonal en acero inox AISI316L
- 6 Maneta de mando en acero inox AISI316L
- 7 Esfera en acero inox AISI316L
- 8 Junta tórica en FKM
- 9 Racor en acero inox AISI316L

Materiais e Componentes

PT

- 1 Corpo em aço-inox AISI 316L
- 2 Vedação da sede da esfera em PTFE
- 3 Eixo em aço-inox AISI316L
- 4 O-ring de Vedação em FKM
- 5 Porca Sextavada em aço-inox AISI316L
- 6 Haste de comando em aço-inox AISI316L
- 7 Esfera em aço-inox AISI316L
- 8 O-ring de Vedação em FKM
- 9 Conexão em aço-inox AISI316L



Pressioni

Pressures

Druckbereich

Pressions

Presiones

Pressões

- 0.99 bar (-0.099 MPa)

40 bar (4 MPa)



Filettatura

Threads

Gas conforme ISO 7.1, BS 21, DIN 2999

Gas in conformity with ISO7.1, BS 21, DIN 2999.

Gewindearten

Filetages

Gewinde nach Norm ISO 7.1, BS 21, DIN 2999

Filetage conforme: ISO7.1, BS 21, DIN 2999.

Roscas

Roscas

Gas conforme ISO 7.1, BS 21, DIN 2999

Gas conforme ISO 7.1, BS 21, DIN 2999



Fluidi compatibili

Aria compressa / Vuoto / Acqua / Oli

Fluidi per Industria alimentare e chimica compatibili con i componenti.

Fluids

Compressed air / Vacuum / Water / Oils

Fluid for food and chemical industry compatible with components.

Geeignete Medien

Druckluft / Vakuum / Wasser / Oel

Medien für die Lebensmittel- und chemische Industrie, die beständig mit den der Verschraubungen sind.

Fluides compatibles

Air comprimé / Vide / Eau / Huile

Fluides alimentaires et chimiques compatibles avec les matériaux constituants.

Fluidos compatibles

Aire comprimido / Vacío / Agua / Aceite

Fluidos para industria alimentaria y química compatibles con los componentes.

Fluidos compatíveis

Ar comprimido / Vácuo / Água / Óleos

Fluidos para Indústria alimentícia e química compatíveis com os componentes.



Temperatura minima

Minimum temperature

Temperatur minimum

Température minimale

Temperatura mínima

Temperatura mínima

- 15 °C

Temperatura massima in continuo

Maximum temperature in continuous

Temperatur maximum kontinuierlich

Température maximale en continu

Temperatura máxima en continuo

Temperatura máxima em contínuo

+ 150 °C

Temperatura massima per breve durata

Maximum temperature for short term

Temperatur maximum für kurzfristig

Pic de température maximale

Temperatura máxima de corta duración

Temperatura máxima em curta duração

+ 180 °C

66300

VALVOLA FEMMINA RP ISO 7 - FEMMINA RP ISO 7

FEMALE RP ISO 7 - FEMALE RP ISO 7 VALVE

KUGELHAHN INNENGEW. RP ISO 7 - INNENGEW. RP ISO 7

ROBINET INOX, TARAUDAGE RP ISO 7

VÁLVULA HEMBRA RP ISO 7 - HEMBRA RP ISO 7

VÁLVULA FÊMEA RP ISO 7 - FÊMEA RP ISO 7



COMPONENT

Code	A	B	DN	CH	F	M	L	G	H	Pack.
66300 00 001	1/8	1/8	5,5	14-15	8,5	8,5	33	28	21,5	2
66300 00 002	1/4	1/4	5,5	16-17	12,5	12,5	43	28	21,5	2

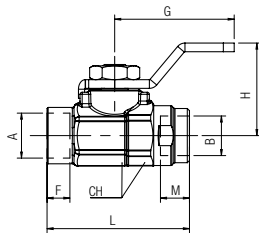

66310

VALVOLA MASCHIO CONICO R ISO 7 - FEMMINA RP ISO 7

TAPER MALE R ISO 7 - FEMALE RP ISO 7 VALVE

KUGELHAHN AUSSENGEW. KONISCH R ISO 7 - INNENGEW. RP ISO 7

ROBINET INOX, FILETAGE R ISO 7 - TARAUDAGE RP ISO 7

VÁLVULA MACHO CÓNICO R ISO 7 - HEMBRA RP ISO 7

VÁLVULA MACHO CÔNICA R ISO 7 - FÊMEA RP ISO 7



COMPONENT

Code	A	B	DN	CH	F	M	L	G	H	Pack.
66310 00 001	1/8	1/8	5,5	14-15	8,5	8,5	35	28	21,5	2
66310 00 002	1/4	1/4	5,5	16-17	12,5	12,5	44,5	28	21,5	2

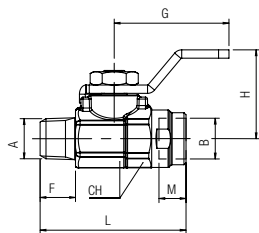

MINIVALVOLA A SFERA A 2-3 VIE

2-3 WAYS MINIBALLVALVE
DREIWEGKUGELHAHN
MINI ROBINET A BOISSEAU SPHERIQUE 2-3 VOIES
MINIVÁLVULA DE ESFERA 2-3 VÍAS
MINI-VÁLVULA DE ESFERA DE 2-3 VIAS



CARATTERISTICHE TECNICHE
TECHNICAL CHARACTERISTICS
TECHNISCHE ANGABEN
CARACTÉRISTIQUES TECHNIQUES
CARACTERÍSTICAS TÉCNICAS
CARACTERÍSTICAS TÉCNICAS



Norma di Riferimento
Reference standard
Entspricht der Norm
Norme de référence
Normativa de referencia
Norma de referència

1907/2006 REACH ✓	2011/65/CE RoHS ✓
PED 2014/68/UE	SILICON FREE

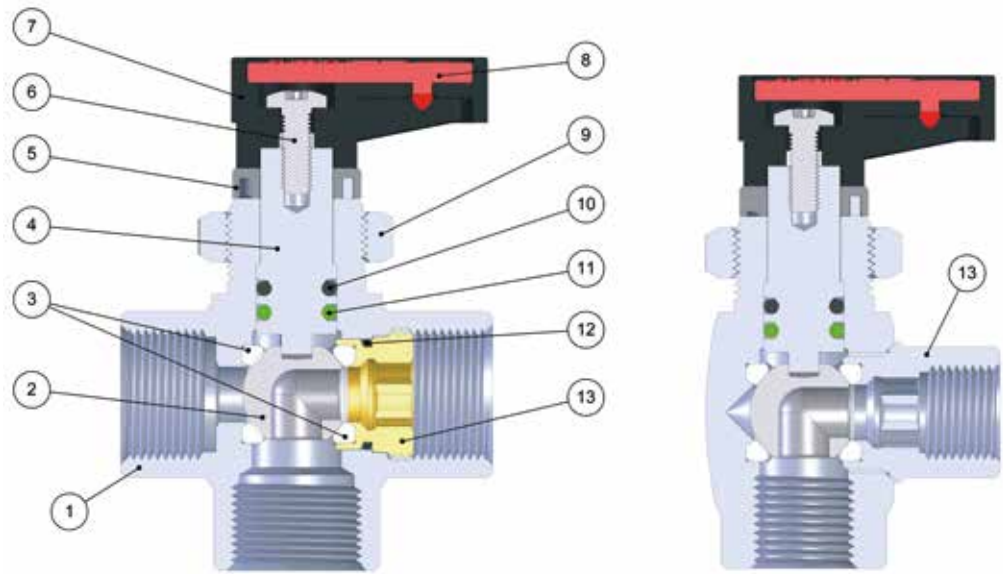

FKM A RICHIESTA
IF REQUESTED FKM
FKM AUF ANFRAGE
FKM SUR DEMANDE
FKM BAJO PEDIDO
FKM SOB ENCOMENDA

Materiali e Componenti	IT	Component Parts and Materials	GB	Komponenten und Materialien	DE
1 Corpo in Ottone cromato		1 Chrome Nickel-plated Brass Body		1 Körper Messing verchromt	
2 Sfera in Ottone cromato		2 Chrome Nickel-plated Brass Ball		2 Kugel Messing verchromt	
3 Guarnizione sede sfera in PTFE		3 PTFE Seat		3 Kugelsitzdichtung PTFE	
4 Albero in Ottone cromato		4 Chrome Nickel-plated Brass Spindle		4 Spindel Messing verchromt	
5 Fermo Maniglia		5 Stop Handle		5 Anschlag	
6 Vite in acciaio		6 Steel Screw		6 Schraube Stahl	
7 Maniglietta in PA66 Caricato vetro		7 PA66 Glass reinforced Handle		7 Handgriff PA66 Glasfaser verstärkt	
8 Piastrina in Resina Acetalica		8 Acetalic resin Plate		8 Griffplatte Acetal	
9 Ghiera per passaparete		9 Bulkhead nut		9 Mutter Messing Vernickelt	
10 Guarnizione O-RING in NBR		10 NBR Seal O-RING		10 O-RING in NBR	
11 Guarnizione O-RING in FKM		11 FKM Seal O-RING		11 O-RING in FKM	
12 Guarnizione O-RING in NBR		12 NBR Seal O-RING		12 O-RING in NBR	
13 Ghiera o raccordo in Ottone		13 Brass Fitting		13 Körper Messing verchromt	

Matériaux et Composants	FR	Materiales y Componentes	ES	Materiais e Componentes	PT
1 Corps: laiton chromé		1 Cuerpo en latón cromado		1 Corpo em latão cromado	
2 Bille: laiton chromé		2 Esfera en latón cromado		2 Esfera em latão cromado	
3 Joint bille sphérique: PTFE		3 Junta de asiento esfera en PTFE		3 Vedação sede da esfera em PTFE	
4 Tige: laiton chromé		4 Eje en latón cromado		4 Arvore em latão cromado	
5 Butée		5 Base Maneta		5 Fixador de manopla	
6 Vis: acier		6 Tornillo en acero		6 Parafuso em aço	
7 Poignée: PA66 chargé en fibre de verre		7 Maneta en PA66 fibra de vidrio		7 Manopla em PA66	
8 Plaquette de poignée: résine acétal		8 Plaqueta en resina acetálica		8 Plaqueta em resina acetálica	
9 Ecrou: Laiton nickelé		9 Tuerca para pasatabiques		9 Porca de fixação passa-muro	
10 Joint torique NBR		10 Junta O-RING en NBR		10 Vedação O-RING en NBR	
11 Joint torique FKM		11 Junta O-RING en FKM		11 Vedação O-RING em FKM	
12 Joint torique NBR		12 Junta O-RING en NBR		12 Vedação O-RING em NBR	
13 Corps: laiton chromé		13 Tuerca o racor en latón		13 Próca e conexão em Latão	



Pressioni

Pressures

Druckbereich

Pressions

Presiones

Pressões

-0.99 (-0.099 MPa)

20 bar (2 MPa)



Temperature

Temperatures

Temperatur

Températures

Temperaturas

Temperaturas

- 20 °C

+ 80 °C

FKM

- 15 °C

+ 130 °C



Fluidi compatibili

Aria compressa / Acqua / Oli

Fluids

Compressed air / Water / Oils

Geeignete Medien

Druckluft / Wasser / Oel

Fluides compatibles

Air comprimé / Eau / Huile

Fluidos compatibles

Aire comprimido / Agua / Aceite

Fluidos compatíveis

Ar comprimido / Água / Óleos



Filettatura

Gas conforme ISO 7.1, BS 21, DIN 2999.
Gas cilíndrica conforme ISO 228 Classe A.

IT

Threads

Gas in conformity with ISO 7.1, BS 21, DIN 2999.
Parallel gas in conformity with ISO 228 Class A.

GB

Gewindearten

Gewinde nach Norm ISO 7.1, BS 21, DIN 2999.
Zylindrisches Gewinde nach Norm ISO 228 Classe A.

DE

Filetages

Filetage conforme: ISO 7.1, BS 21, DIN 2999.
Filetage cylíndrique conforme: ISO 228 Classe A.

FR

Roscas

Gas conforme ISO 7.1, BS 21, DIN 2999.
Gas cilíndrica conforme ISO 228 Classe A.

ES

Roscas

Gas conforme ISO 7.1, BS 21, DIN 2999.
Gas paralela conforme ISO 228 Classe A.

PT

6700

No Gas

VALVOLA TRE VIE A L FEMMINA G ISO 228

3 WAYS VALVE "L" FEMALE G ISO 228

DREIWEGEKUGELHAHN INNENGEW. G ISO 228

ROBINET A VOIES TARAUDAGE G ISO 228

VÁLVULA A 3 VÍAS HEMBRA G ISO 228

VÁLVULA DE TRÊS VIAS ROSCA FÊMEA G ISO 228

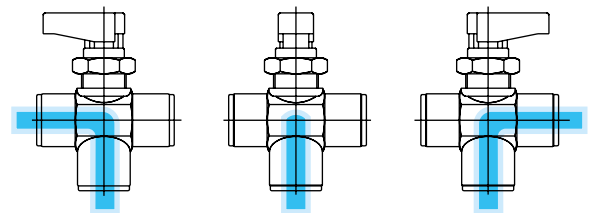
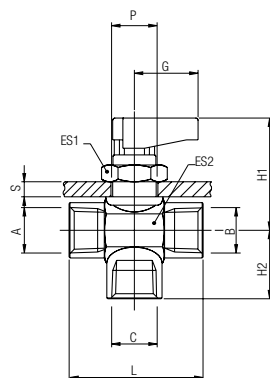

Code	A	B	C	DN	ES1	ES2	L	G	H1	H2	S max	P	Pack.
06700 00 001	1/8	1/8	1/8	5	17	17	35	19	33.5	15.5	4.5	14.5	10
06700 00 002	1/4	1/4	1/4	5	17	17	37	19	33.5	17.5	4.5	14.5	10
06700 00 003	3/8	3/8	3/8	7	17	21	42	19	35	19.5	4.5	14.5	10

6710

No Gas

VALVOLA TRE VIE A T FEMMINA G ISO 228

3 WAYS VALVE "T" FEMALE G ISO 228

DREIWEGEKUGELHAHN INNENGEW. G ISO 228

ROBINET A VOIES TARAUDAGE G ISO 228

VÁLVULA A 3 VÍAS HEMBRA G ISO 228

VÁLVULA DE TRÊS VIAS ROSCA FÊMEA G ISO 228

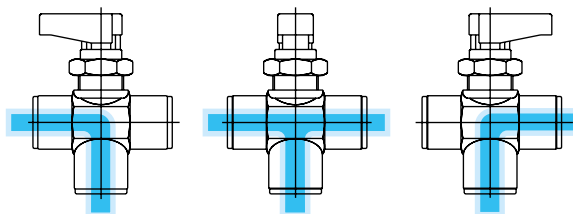
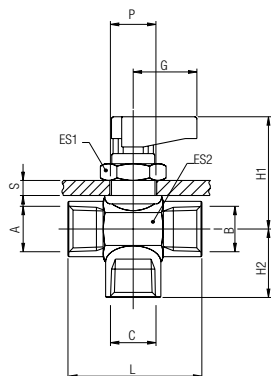

Code	A	B	C	DN	ES1	ES2	L	G	H1	H2	S max	P	Pack.
06710 00 001	1/8	1/8	1/8	5	17	17	35	19	33.5	15.5	4.5	14.5	10
06710 00 002	1/4	1/4	1/4	5	17	17	37	19	33.5	17.5	4.5	14.5	10
06710 00 003	3/8	3/8	3/8	7	17	21	42	19	35	19.5	4.5	14.5	10

6720

No Gas

VALVOLA A L FEMMINA G ISO 228

VALVE "L" FEMALE G ISO 228

WINKELKUGELHAHN INNENGEW. G ISO 228

ROBINET EQUERRE, FILETAGE G ISO 228

VÁLVULA A L HEMBRA G ISO 228

VÁLVULA EM "L" ROSCA FÊMEA G ISO 228

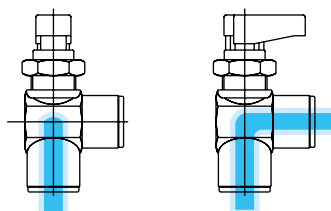
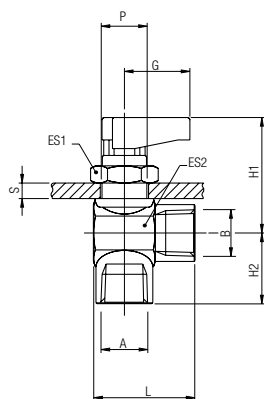

Code	A	B	DN	ES1	ES2	L	G	H1	H2	S max	P	Pack.
06720 00 001	1/8	1/8	5	17	17	28.5	19	33.5	15.5	4.5	14.5	10
06720 00 002	1/4	1/4	5	17	17	28.5	19	33.5	17.5	4.5	14.5	10
06720 00 003	3/8	3/8	7	17	21	31	19	35	19.5	4.5	14.5	10

ACCESSORI

ACCESSORIES
ZUBEHÖR
ACCESSOIRES
ACCESORIOS
ACESÓRIOS

6900

MANIGLIA CORTA

SHORT HANDLE
HANDGRIFF KURZ
POIGNÉE COURT
MANETA CORTA
MANOPLA CURTA

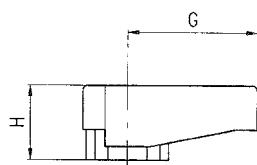

Code	Type	G	H	Pack.
06900 A0 30 00 00	A	19	11	20
06900 B0 30 00 00	B	26	15	20

A = Per valvole da 1/8 - 1/4 - 3/8.
For valves of 1/8 - 1/4 - 3/8.
Für Kugelhähne mit 1/8 - 1/4 - 3/8.
Pour vannes 1/8 - 1/4 - 3/8.
Para válvulas de 1/8 - 1/4 - 3/8.
Para válvulas de 1/8 - 1/4 - 3/8.

B = Per valvole da 1/2 - 3/4.
For valves of 1/2 - 3/4.
Für Kugelhähne mit 1/2 - 3/4.
Pour vannes of 1/2 - 3/4.
Para válvulas de 1/2 - 3/4.
Para válvulas de 1/2 - 3/4.

Maniglia CORTA standard per valvola da 1/8-1/4-3/8-1/2.
Standard SHORT Handle for Valve 1/8-1/4-3/8-1/2.
Handgriff KURZ Standard für 1/8-1/4-3/8-1/2.
Poignée COURTE en standard pour 1/8-1/4-3/8-1/2.
Maneta CORTA estándar para válvula de 1/8-1/4-3/8-1/2.
Manopla CURTA standard para válvula de 1/8-1/4-3/8-1/2.

6910

MANIGLIA LUNGA

LONG HANDLE
HANDGRIFF LANG
POIGNÉE RALLONGÉE
MANETA LARGA
MANOPLA LONGA

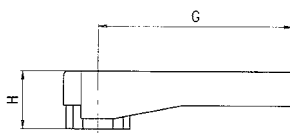

Code	Type	G	H	Pack.
06910 A0 30 00 00	A	35	11	20
06910 B0 30 00 00	B	50	15	20

A = Per valvole da 1/8 - 1/4 - 3/8.
For valves of 1/8 - 1/4 - 3/8.
Für Kugelhähne mit 1/8 - 1/4 - 3/8.
Pour vannes 1/8 - 1/4 - 3/8.
Para válvulas de 1/8 - 1/4 - 3/8.
Para válvulas de 1/8 - 1/4 - 3/8.

B = Per valvole da 1/2 - 3/4.
For valves of 1/2 - 3/4.
Für Kugelhähne mit 1/2 - 3/4.
Pour vannes of 1/2 - 3/4.
Para válvulas de 1/2 - 3/4.
Para válvulas de 1/2 - 3/4.

Maniglia LUNGA standard per valvola da 3/4.
standard LONG Handle for Valve 3/4.
Handgriff LANG Standard für 3/4.
Poignée RALLONGÉE en standard pour 3/4.
Maneta LARGA estándar para válvula de 3/4.
Manopla LONGA standard para válvula de 3/4.

6915

PROLUNGA ALBERO DI COMANDO (CON MANIGLIA LUNGA, VITE)

SPINDLE EXTENSION (WITH LONG HANDLE, SCREW)
VERLÄNGERTE SCHALTWELLE (MIT LANGEM GRIFF UND SCHRAUBE)
EXTENSION AVEC POIGNÉE LONGUE ET VIS
PROLONGACIÓN EJE DE MANDO (CON MANETA LARGA, TORNILLO Y PLAQUETA)
PROLONGAMENTO DE EIXODE COMANDO (COM MANOPLA LONGA, PAREFUSOS)

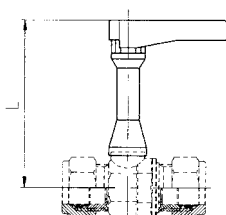

Code	Type	Valve size	L	Pack.
06915 00 001	A	1/8	58	10
		1/4	58	
		3/8	59	
06915 00 002	B	1/2	68	10
		3/4	70	

6920

PIASTRINA COLORATA
 COLOURED PLATE
 HANDGRIFF FARBEN
 PLAQUETTE DE COULEURS
 PLAQUETA COLOREADA
 PLAQUETA COLORIDA



Code	Type	Color	Pack.
06920 A0 30 00 RO	A	Red	100
06920 B0 30 00 RO	B	Red	100
06920 A0 30 00 GI	A	Yellow	100
06920 B0 30 00 GI	B	Yellow	100
06920 A0 30 00 BL	A	Blue	100
06920 B0 30 00 BL	B	Blue	100
06920 A0 30 00 VE	A	Green	100
06920 B0 30 00 VE	B	Green	100
06920 A0 30 00 BN	A	White	100
06920 B0 30 00 BN	B	White	100

6680

DADO
 NUT
 ÜBERWURFMUTTER
 ECROU
 TUERCA
 PORCA

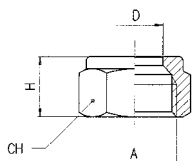

Code	D	A	H	CH	Pack.
06680 00 01 BS CT	6	1/8	11	12	100
06680 00 01 BJ CT	8	1/4	12	15	100
06680 00 01 CG CT	10	3/8	13	19	100
06680 00 01 CL CT	12	3/8	14	19	100
06680 00 01 DB CT	14	1/2	15	24	100
06680 00 01 CP CT	15	1/2	15	24	100
06680 00 01 CS CT	16	3/4	17	30	100
06680 00 01 CX CT	18	3/4	17	30	100

10740

OGIVA OTTONE
 BRASS OLIVE
 KLEMMRING MESSING
 BAGUE LAITON
 BICONO LATÓN
 BUCHA DE LATÃO

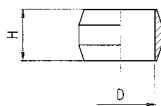

Code	D	H	Pack.
10740 00 02 X4 00	6	6.5	50
10740 00 02 X7 00	8	6.5	50
10740 00 02 X9 00	10	7.5	50
10740 00 02 Y1 00	12	8	50
10740 00 02 Y4 00	15	9	20
10740 00 02 Y7 00	18	10	20

10741

OGIVA OTTONE
 BRASS OLIVE
 KLEMMRING MESSING
 BAGUE LAITON
 BICONO LATÓN
 BUCHA DE LATÃO

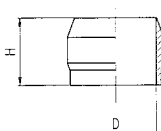

Code	D	H	Pack.
10741 00 01 Y3 00	14	12	50
10741 00 01 Y5 00	16	13.5	50

10760

OGIVA PTFE
 PTFE OLIVE
 KLEMMRING PTFE
 BAGUE PTFE
 BICONO PTFE
 BUCHA DE PTFE



Code	D	H	Pack.
10760 00 28 X4 00	6	6.5	50
10760 00 28 X7 00	8	6.5	50
10760 00 28 X9 00	10	7.5	50
10760 00 28 Y1 00	12	8	50
10760 00 28 Y4 00	15	9	50
10760 00 28 Y7 00	18	10	50

10761

OGIVA PTFE
 PTFE OLIVE
 KLEMMRING PTFE
 BAGUE PTFE
 BICONO PTFE
 BUCHA DE PTFE

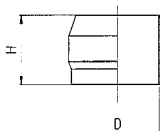

Code	D	H	Pack.
10761 00 28 Y3 00	14	12	50
10761 00 28 Y5 00	16	13.5	50

MINIVALVOLE A SFERA

MINIBALL VALVES
 MINI-KUGELHÄHNE
 ROBINET MINI
 MINI VÁLVULAS A ESFERA
 MINI VÁLVULAS DE ESFERA



Norma di Riferimento

Reference standard

Entspricht der Norm

Norme de référence

Normativa de referencia

Norma de referência

1907/2006

REACH ✓

2011/65/CE

RoHS ✓

PED
2014/68/UE

SILICON
FREE

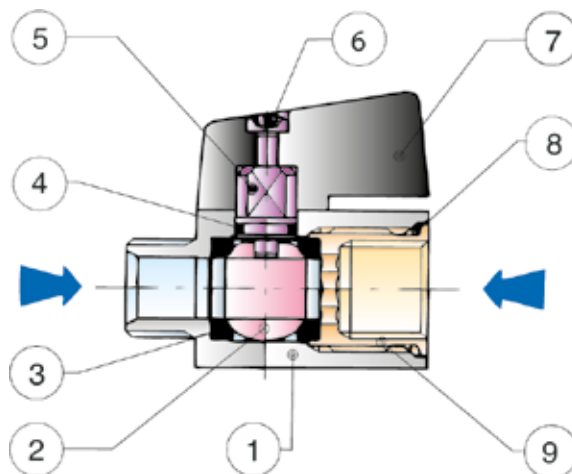

Materiali e Componenti

IT

- 1 Corpo in Ottone nichelato
- 2 Sfera in Ottone nichelato
- 3 Guarnizione sede sfera in PTFE
- 4 Guarnizione O-RING in NBR
- 5 Albero in Ottone nichelato
- 6 Vite in acciaio
- 7 Maniglia in PA66 Caricato vetro - 3/4 alluminio
- 8 Guarnizione O-RING in NBR
- 9 Ghiera o raccordo in Ottone nichelato

Component Parts and Materials

GB

- 1 Nickel-plated Brass Body
- 2 Nickel-plated Brass Ball
- 3 PTFE Seats
- 4 NBR Seal O-RING
- 5 Nickel-plated Brass Spindle
- 6 Steel Screw
- 7 PA66 Glass reinforced Handle -3/4 Aluminium
- 8 NBR Seal O-RING
- 9 Nickel-plated Brass Fitting

Komponenten und Materialien

DE

- 1 Körper Messing vernickelt
- 2 Kugel Messing vernickelt
- 3 Kugelsitzdichtung PTFE
- 4 O-Ring NBR
- 5 Spindel Messing vernickelt
- 6 Schraube Stahl
- 7 Handgriff PA66 Glasfaser verstärkt - 3/4 Aluminium
- 8 O-Ring NBR
- 9 Gewindeinsatz Messing vernickelt

Matériaux et Composants

FR

- 1 Corps: laiton nickelé
- 2 Bille: laiton nickelé
- 3 Joint bille sphérique: PTFE
- 4 Joint tige: NBR
- 5 Tige: laiton nickelé
- 6 Vis: acier
- 7 Poignée: PA66 chargé en fibre de verre - 3/4 Aluminium
- 8 Joint tige: NBR
- 9 Ecrou de blocage: laiton nickelé

Materiales y Componentes

ES

- 1 Cuerpo en latón niquelado
- 2 Esfera en latón niquelado
- 3 Junta sede esfera en PTFE
- 4 Junta tórica O-RING en NBR
- 5 Eje en latón niquelado
- 6 Tornillo en acero
- 7 Maneta en PA66 con fibra de vidrio - 3/4 aluminio
- 8 Junta tórica O-RING en NBR
- 9 Racor en latón niquelado

Materiais e Componentes

PT

- 1 Corpo em Latão Niquelado
- 2 Esfera em Latão Niquelado
- 3 Vedação da sede da esfera em PTFE
- 4 Vedação O-RING em NBR
- 5 Eixo em Latão Niquelado
- 6 Parafuso em aço
- 7 Manopla em PA66 com Fibra de Vidro - 3/4 Alumínio
- 8 Vedação O-RING em NBR
- 9 Conexão em Latão Niquelado



Pressioni

Pressures

Druckbereich

Pressions

Presiones

Pressões

-0.99 (-0.099 MPa)

10 bar (1 MPa)



Temperature

Temperatures

Temperatur

Températures

Temperaturas

Temperaturas

- 15 °C
+ 110 °C

Con Acqua
With Water
Mit Wasser
Avec de l'Eau
Con Agua
Com Água

0 °C
+ 90 °C



Fluidi compatibili

Aria compressa / Acqua / Oli / Vuoto

Fluids

Compressed air / Water / Oils / Vacuum

Geeignete Medien

Druckluft / Wasser / Verschiedene Oele / Vakuum

Fluides compatibles

Air comprimé / Eau / Huiles / Vide

Fluidos compatibles

Aire comprimido / Agua / Aceite / Vacío

Fluidos compatíveis

Ar comprimido / Água / Óleos / Vazio

6065

No Gas

VALVOLA A SFERA MINI FEMMINA G ISO 228 - FEMMINA G ISO 228

MINI BALL VALVE FEMALE G ISO 228 - FEMALE G ISO 228
 MINI-KUGELHAHN INNENGEW. G ISO 228 - INNENGEW. G ISO 228
 MINI ROBINET TARAUDAGE G ISO 228
 VÁLVULA A ESFERA MINI HEMBRA G ISO 228 - HEMBRA G ISO 228
 MINI-VÁLVULA DE ESFERA FÊMEA G ISO 228 - FÊMEA G ISO 228

Code	A	DN	B	C	CH	Pack.
06065 00 001	1/8	6	39	38	21	10
06065 00 002	1/4	8	40	38	21	10
06065 00 003	3/8	8	42	38	21	10
06065 00 004	1/2	10	48	42	25	10
06065 00 005	3/4	12	54	47	30	10

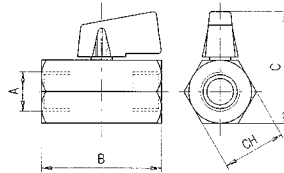

6066

No Gas

VALVOLA A SFERA MINI MASCHIO G ISO 228 - FEMMINA G ISO 228

MINI BALL VALVE MALE G ISO 228 - FEMALE G ISO 228
 MINI-KUGELHAHN AUSSENGEW. GA ISO 228 - INNENGEW. G ISO 228
 MINI ROBINET FILETAGE - TARAUDAGE G ISO 228
 VÁLVULA A ESFERA MINI MACHO G ISO 228 - HEMBRA G ISO 228
 MINI-VÁLVULA DE ESFERA ROSCA MACHO G ISO 228 - ROSCA FÊMEA G ISO 228

Code	A	DN	B	C	CH	Pack.
06066 00 001	1/8	6	39	38	21	10
06066 00 002	1/4	8	39	38	21	10
06066 00 003	3/8	8	40	38	21	10
06066 00 004	1/2	10	46	42	25	10
06066 00 005	3/4	12	51	47	30	10

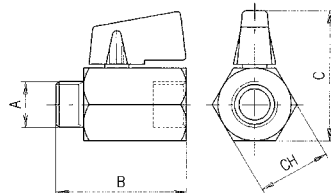

VALVOLE A SFERA

**BALL VALVES
KUGELHÄHNE
ROBINET A BOISSEAU SPHERIQUE
VÁLVULAS A ESFERA
VÁLVULAS DE ESFERA**



Norma di Riferimento

Reference standard

Entspricht der Norm

Norme de référence

Normativa de referencia

Norma de referência

1907/2006 REACH ✓	2011/65/CE RoHS ✓
PED 2014/68/UE	SILICON FREE

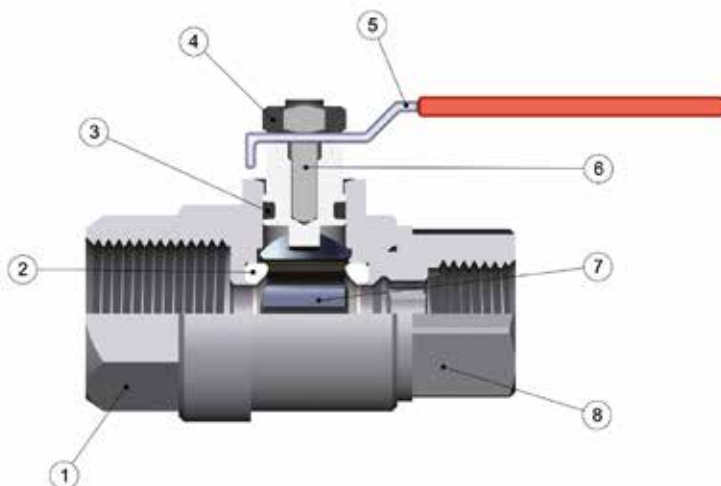

Materiali e Componenti

IT

- 1 Corpo in ottone nichelato
- 2 Guarnizione sede sfera in PTFE
- 3 Guarnizione asta: 6068 FKM
6067/6069 EPDM
- 4 Dado per leva in Acciaio
- 5 Leva di manovra in acciaio plastificato
- 6 Asta di manovra in ottone nichelato
- 7 Sfera in ottone cromato
- 8 Raccordo in Ottone Nichelato

Component Parts and Materials

GB

- 1 Nickel-plated Brass Body
- 2 PTFE Seats
- 3 Stem Seal: 6068 FKM
6067/6069 EPDM
- 4 Steel Nut for lever
- 5 Steel plastified Lever handle
- 6 Nickel-plated Brass Stem
- 7 Chrome Nickel-plated Brass Ball
- 8 Nickel-plated Brass Fitting

Komponenten und Materialien

DE

- 1 Körper Messing vernickelt
- 2 Kugelsitzdichtung PTFE
- 3 Spindeldichtung: 6068 FKM
6067/6069 EPDM
- 4 Hebelmutter Stahl
- 5 Bedienhebel Stahl plastifiziert
- 6 Bedienspindel Messing vernickelt
- 7 Kugel Messing verchromt
- 8 Einschraubkörper Messing vernickelt

Matériaux et Composants

FR

- 1 Corps: laiton nickelé
- 2 Joint de forme: PTFE
- 3 Joint de tige: 6068 FKM
6067/6069 EPDM
- 4 Ecrou de blocage: acier
- 5 Poignée plastifiée: acier
- 6 Tige: laiton nickelé
- 7 Bille: laiton chromé
- 8 Raccord: laiton nickelé

Materiales y Componentes

ES

- 1 Cuerpo en latón cromado
- 2 Junta sede esfera PTFE
- 3 Junta eje: 6068 FKM
6067/6069 EPDM
- 4 Junta para leva en Acero
- 5 Leva de maniobra en acero plastificado
- 6 Eje de maniobra en latón niquelado
- 7 Esfera en latón cromado
- 8 Racor en latón niquelado

Materiais e Componentes

PT

- 1 Corpo em Latão Niquelado
- 2 Vedação da sede da esfera em PTFE
- 3 Vedação da haste: 6068 FKM
6067/6069 EPDM
- 4 Dado per leva em Aço
- 5 Manopla de manobra em aço plastificado
- 6 Haste de manobra em Latão Niquelado
- 7 Esfera em Latão cromado
- 8 Conexões em Latão Niquelado

DIAGRAMMA PRESSIONE-TEMPERATURA

PRESSURE-TEMPERATURE RATINGS DIAGRAM
DRUCK-TEMPERATUR DIAGRAMM
DIAGRAMME PRESSION / TEMPÉRATURE
DIAGRAMA PRESIÓN-TEMPERATURA
DIAGRAMA PRESSÃO-TEMPERATURA

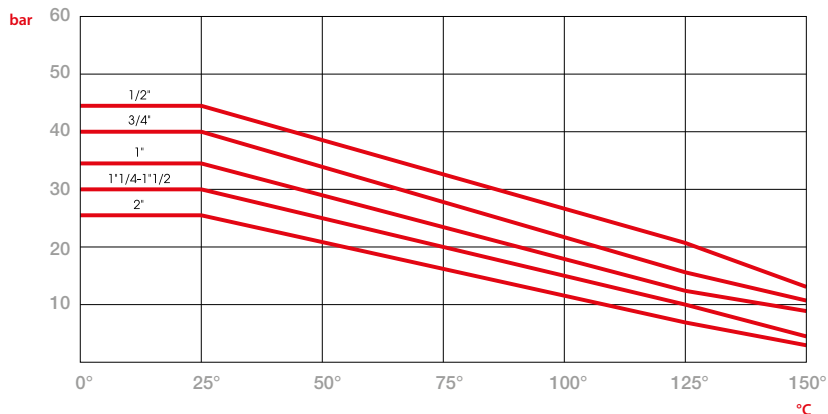

6067

VALVOLA A SFERA, FEMMINA G ISO 228 - FEMMINA G ISO 228

BALL VALVE, FEMALE G ISO 228 - FEMALE G ISO 228
 KUGELHAHN, INNENGEW. G ISO 228 - INNENGEW. G ISO 228
 ROBINET TARAUDAGE G ISO 228
 VÁLVULA A ESFERA HEMBRA G ISO 228 - HEMBRA G ISO 228
 VÁLVULA DE ESFERA, FÊMEA G ISO 228 - FÊMEA G ISO 228

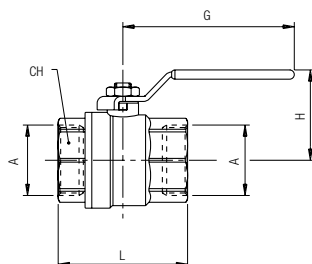

Code	A	DN	CH	L	G	H	Pack.
06067 00 001	1/2	15	25	46	88	47.5	10
06067 00 002	3/4	20	31	56.5	88	51	10
06067 00 003	1"	25	38	65.5	105	63	5
06067 00 004	1"1/4	32	48	77	105	68.5	2
06067 00 005	1"1/2	40	54	88.5	134	84.5	1
06067 00 006	2"	50	67	101.5	134	92.5	1



Fluidi compatibili
 Aria compressa / Acqua

Fluids
 Compressed air / Water

Geeignete Medien
 Druckluft / Wasser

Fluides compatibles
 Air comprimé / Eau

Fluidos compatibles
 Aire comprimido / Agua

Fluidos compatíveis
 Ar comprimido / Água

IT	<ul style="list-style-type: none"> Fino al DN20: Valgono le condizioni riportate nel diagramma Dal DN25 al DN50: Pressione Max: 18 bar 	GB	<ul style="list-style-type: none"> DN 15 and 20: Use Diagram condition From DN25 to DN50: Max Pressure: 18 bar
DE	<ul style="list-style-type: none"> Bis zu DN20: Verwenden Sie die Angaben im Diagramm Von DN25 bis DN50: Max. Druck: 18 bar 	FR	<ul style="list-style-type: none"> DN 15 et 20: Pour définir la pression maximale, consulter le diagramme De DN25 jusqu'à DN50: pression maximum: 18 bar
ES	<ul style="list-style-type: none"> Hasta el DN20: Ver los valores representados en el diagrama Del DN25 al DN50, Presión Máx: 18 bar 	PT	<ul style="list-style-type: none"> DN15 e DN20: Verifique as condições informadas no diagrama De DN25 a DN50, Pressão Máx: 18 bar

6068

VALVOLA A SFERA PER GAS, FEMMINA RP ISO7 - FEMMINA RP ISO7

GAS BALL VALVE, FEMALE RP ISO7 - FEMALE RP ISO7
 KUGELHAHN FÜR GAS, INNENGEW. RP ISO7 - INNENGEW. RP ISO7
 ROBINET POUR GAZ - TARAUDAGE RP ISO 7
 VÁLVULA A ESFERA PARA GAS HEMBRA RP ISO7 - HEMBRA RP ISO7
 VÁLVULA DE ESFERA PARA GÁS, ROSCA FÊMEA RP ISO7 - ROSCA FÊMEA RP ISO7

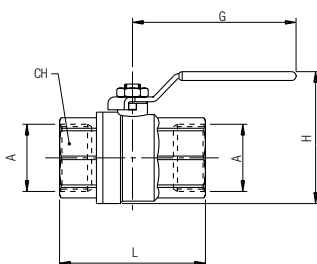

Code	A	DN	CH	L	G	H	Pack.
06068 00 007	1/4	10	22	46	88	50	10
06068 00 008	3/8	12	22	46	88	50	10
06068 00 001	1/2	15	26	59	88	58	10
06068 00 002	3/4	20	32	67.3	88	65	10
06068 00 003	1"	25	40	77.5	105	74	5
06068 00 004	1"1/4	32	49	92	105	85	2
06068 00 005	1"1/2	40	55	101.5	134	100	1
06068 00 006	2"	50	68	122.5	134	116.5	1



Omologato BS EN 331:2015
 fino a pressione Max: 5 bar.

Omologated BS EN 331:2015
 to Max pressure: 5bar.

Zugelassen nach BS EN 331:2015
 bis zu einem max. Druck von 5 bar.

Homologué BS EN 331:2015
 jusqu'à une pression de: 5bar.

Homologado BS EN 331:2015
 hasta presión Máx: 5 bar.

Homologadas BS EN 331:2015
 até a pressão Máx: 5 bar.



Fluidi	IT	Fluids	GB
Dal DN15 al DN50: 1° e 2° Famiglia di gas a media pressione e 3° famiglia di gas a bassa pressione.		From DN 15 to 50: Fluids: 1st and 2nd gas family to medium pressure 3th gas family to low pressure.	
Medien	DE	Fluides	FR
Von DN15 bis DN50: 1. und 2. Familie von Gasen für Mitteldruck und 3. Familie von Gasen für Niederdruck.		De DN15 jusqu'à DN50: 1ère et 2ème famille des gaz moyenne pression et 3ème famille des gaz basse pression.	
Fluidos	ES	Fluidos	PT
Del DN15 al DN50: 1ª y 2ª Familia de gases a media presión y 3ª familia de gas a baja presión.		De DN15 a DN50: 1º e 2º Familia de gás a média pressão e 3º família de gás a baixa pressão.	

6069

VALVOLA A SFERA MASCHIO G ISO 228 - FEMMINA G ISO 228

BALL VALVE MALE G ISO 228 - FEMALE G ISO 228

KUGELHAHN, AUSSENGEW. G ISO 228 - INNENGEW. G ISO 228

ROBINET, FILETAGE G ISO 228 - TARAUDAGE G ISO 228

VÁLVULA A ESFERA MACHO G ISO 228 - HEMBRA G ISO 228

VÁLVULA DE ESFERA ROSCA MACHO G ISO 228 - ROSCA FÊMEA G ISO 228

Code	A	B	DN	CH	L	G	H	Pack.
06069 00 001	1/2	1/2	15	25	56	88	47.5	10
06069 00 002	3/4	3/4	20	31	63.5	88	51	10
06069 00 003	1"	1"	25	38	74	105	63	5
06069 00 004	1 1/4	1 1/4	32	48	85	105	68.5	2
06069 00 005	1 1/2	1 1/2	40	54	100	134	84.5	1
06069 00 006	2"	2"	50	67	121.5	134	92.5	1

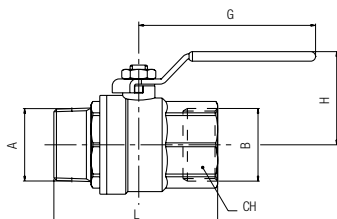

Fluidi compatibili

Aria compressa / Acqua

Fluids

Compressed air / Water

Geeignete Medien

Druckluft / Wasser

Fluides compatibles

Air comprimé / Eau

Fluidos compatibles

Aire comprimido / Agua

Fluidos compatíveis

Ar comprimido / Água

IT
GB

- Fino al DN20:
Valgono le condizioni riportate nel diagramma.
- Dal DN25 al DN50: Pressione Max: 18 bar

- DN 15 and 20:
Use Diagram condition.
- From DN25 to DN50: Max Pressure: 18 bar

DE
FR

- Bis zu DN20:
Verwenden Sie die Angaben im Diagramm.
- Von DN25 bis DN50: Max. Druck: 18 bar

- DN 15 et 20:
Pour définir la pression maximale, consulter le diagramme.
- De DN25 jusqu'à DN50: pression maximum: 18 bar

ES
PT

- Hasta el DN20:
Ver los valores representados en el diagrama.
- Del DN25 al DN50, Presión Máx: 18 bar

- DN15 e DN20:
Verifique as condições informadas no diagrama.
- De DN25 a DN50, Pressão Máx: 18 bar

VALVOLE A SFERA A 3 VIE PASSAGGIO A "T" E A "L"

3 WAYS BALL VALVES FEMALE - "T" & "L"
 3-WEGE KUGELHAHN MIT "L" UND "T" BOHRUNG
 ROBINET A 3 VOIES PASSAGE EN "T" ET EN "L"
 VÁLVULA DE ESFERA A 3 VÍAS PASO A "T" Y A "L"
 VÁLVULA ESFERA 3 VIAS COM PASSAGEM "T" E "L"



CARATTERISTICHE TECNICHE

TECHNICAL CHARACTERISTICS
 TECHNISCHE ANGABEN
 CARACTÉRISTIQUES TECHNIQUES
 CARACTERÍSTICAS TÉCNICAS
 CARACTERÍSTICAS TÉCNICAS



Norma di Riferimento

Reference standard

Entspricht der Norm

Norme de référence

Normativa de referencia

Norma de referència

1907/2006
 REACH ✓

2011/65/CE
 RoHS ✓

PED
 2014/68/UE

SILICON
 FREE

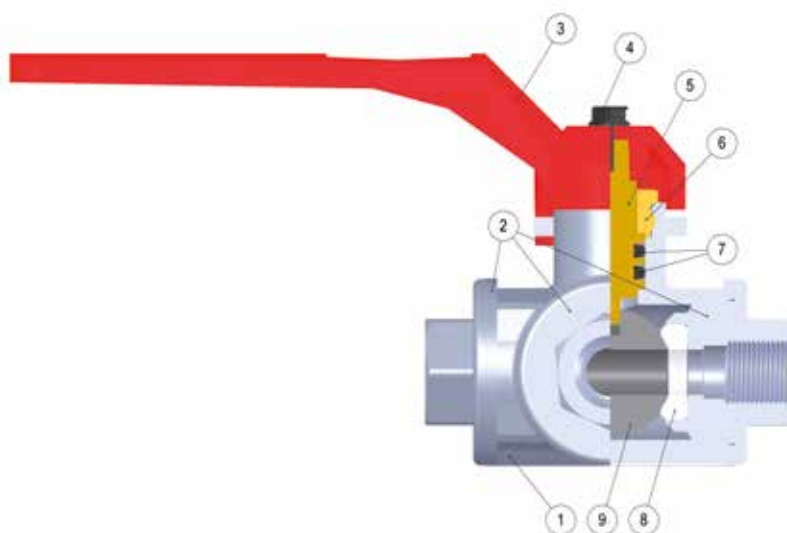

Materiali e Componenti	IT
1	Corpo in ottone nichelato
2	Raccordi in ottone nichelato
3	Leva in alluminio EN-AB46100
4	Vite acciaio zincato
5	Asta di manovra in ottone giallo
6	Premiguarnizione in ottone giallo
7	Guarnizione asta FKM
8	Guarnizione sede sfera in PTFE
9	Sfera in ottone cromato

Component Parts and Materials	GB
1	Nickel-plated brass body
2	Nickel-plated brass adaptors
3	Aluminum handle EN-AB46100
4	Zinc plated screw
5	Handling needle in yellow brass
6	Seal locker in yellow brass
7	Needle seal FKM
8	Ball seat seal PTFE
9	Chrome-plated brass ball

Komponenten und Materialien	DE
1	Körper Messing vernickelt
2	Anschlüsse Messing vernickelt
3	Griff Aluminium EN-AB46100
4	Schraube Stahl verzinkt
5	Spindel Messing
6	Hülse Messing
7	Dichtung Spindel FKM
8	Kugelsitzdichtung PTFE
9	Kugel Messing verchromt

Matériaux et Composants	FR
1	Corps en laiton nickelé
2	Raccordement en laiton nickelé
3	Poignée en aluminium EN-AB46100
4	Vis en acier zing ué
5	Tige en laiton
6	Axe de tige en laiton
7	Joint de tige en FKM
8	Joint de forme en PTFE
9	Bille laiton chromé

Materiales y Componentes	ES
1	Cuerpo en latón niquelado
2	Racores en latón niquelado
3	Leva en aluminio EN-AB46100
4	Tornillo en acero zincado
5	Eje de maniobra en latón natural
6	Sujeta junta en latón natural
7	Junta eje en FKM
8	Junta sede esfera en PTFE
9	Esfera en latón cromado

Materiais e Componentes	PT
1	Corpo em latão niquelado
2	Conexões em latão niquelado
3	Alavanca em alumínio EM-AB46100
4	Parafusos em aço zincado
5	Haste de manobra em latão amarelo
6	Prensa-vedações em latão amarelo
7	Vedações da haste em FKM
8	Vedações da base da esfera em PTFE
9	Esfera em latão cromado



Temperature

Temperatures

Temperatur

Températures

Temperaturas

Temperaturas

- 10 °C

+ 120 °C



Fluidi compatibili

Aria compressa / Vuoto / Acqua / Oli

Fluids

Compressed air / Vacuum / Water / Oils

Geeignete Medien

Druckluft / Vakuum / Wasser / Oel

Fluides compatibles

Air comprimé / Vide / Eau / Huile

Fluidos compatibles

Aire comprimido / Vacío / Agua / Aceite

Fluidos compatíveis

Ar comprimido / Vácuo / Água / Óleos



Diagramma Pressione - Temperatura

Pressure - Temperature ratings diagram

Druck - Temperatur diagramm



Diagramme Pression - Température

Diagrama Presión - Temperatura

Diagrama de Pressão - Temperatura

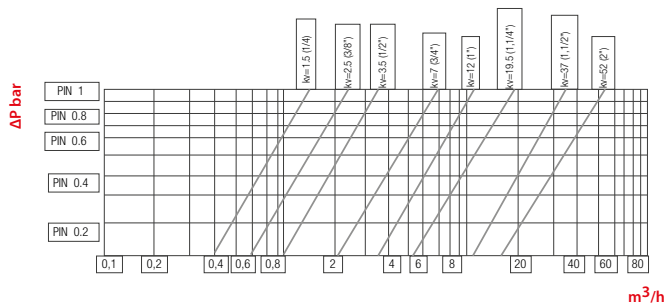
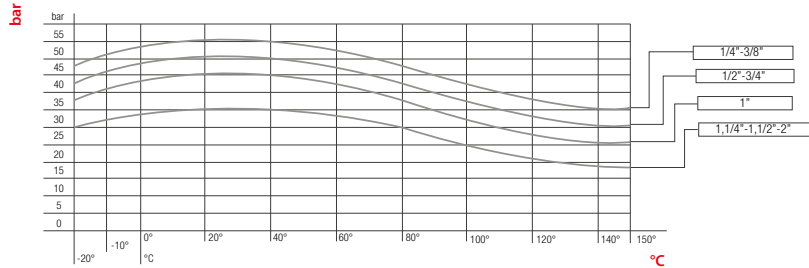

Attenzione

IT

La presente valvola deve essere impiegata alle condizioni esposte in questa scheda, e dalla misura 1 - 1/4" e superiori, non deve essere utilizzata per fluidi pericolosi quali: esplosivi, infiammabili, tossici e comburenti.

Attention

GB

This valve must be used at the above described conditions. From size 1-1/4" and bigger, do not use with dangerous fluids: explosives, inflammables, inflammables, toxic and combusive.

Achtung

DE

Dieses Ventil muss unter den in diesem Anhang angegebenen Bedingungen verwendet werden. Die Abmessungen 1 1/4" und grösser, dürfen nicht für gefährliche Flüssigkeiten verwendet werden, wie zum Beispiel: hochexplosive, entzündliche, giftige und oxidierende.

Attention

FR

Ces robinets doivent être utilisée dans le tableau ci dessus. A partir de 1 - 1/4 " ils ne doivent pas être utilisés pour des fluides dangereux (explosifs, produits inflammables, produits toxiques...).

Atención

ES

La presente válvula debe ser utilizada a las condiciones expuestas en esta tabla, y desde la medida 1 - 1/4" y superior, no debe ser utilizada para fluidos peligrosos tales como: explosivos, inflamables, tóxicos y oxidantes.

Atenção

PT

A presente válvula deve ser aplicada às condições expostas neste tabela, e nas medidas 1-1/4" e superiores não deve ser utilizada para fluidos perigosos, tais como: explosivos, inflamáveis, tóxicos e comburentes.



Filettatura

IT

Gas cilindrica conforme ISO 228 Classe A.

Threads

GB

Parallel gas in conformity with ISO 228 Class A.

Gewindearten

DE

Zylindrisches Gewinde nach Norm ISO 228 Classe A.

Filetages

FR

Filetage cylindrique conforme: ISO 228 Classe A.

Roscas

ES

Gas cilindrica conforme ISO 228 Clase A.

Roscas

PT

Gas paralela conforme ISO 228 Classe A.

6074

VALVOLA 3 VIE A L FEMMINA G ISO 228

3 WAYS BALL VALVE "L" FEMALE G ISO 228
 3-WEGE WINKEL-KUGELHAHN INNENGEW. G ISO 228
 ROBINET 3 VOIES EN L TARAUEE G ISO 228
 VÁLVULA 3 VIAS A L HEMBRA G ISO 228
 VÁLVULA 3 VIAS EM "L" ROSCA FÊMEA G ISO 228

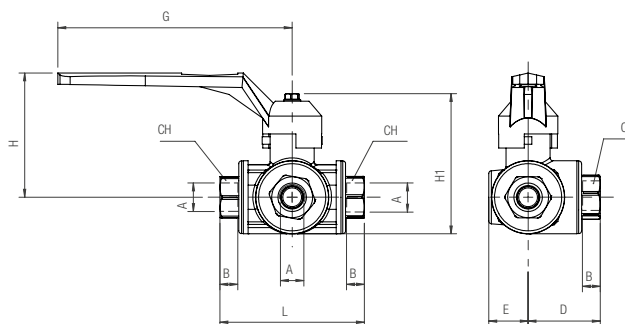

Code	A	B	H	D	L	G	H1	E	CH	DN	PN 20°/40 °C	Pack.
06074 V0 001	1/4	18	65	38,5	77	125	75	22	22	10	55	2
06074 V0 002	3/8	18	65	38,5	77	125	75	22	22	12	55	2
06074 V0 003	1/2	18	65	38,5	77	125	75	22	27	14	50	2
06074 V0 004	3/4	22	83	46	92	145	91	25	34	18	50	2
06074 V0 005	1"	23	96	52	104	170	105	30	41	23	45	2
06074 V0 006	1" - 1/4	26	102	59	118	170	115	34	50	29	35	1
06074 V0 007	1" - 1/2	30	109	69	138	170	128	40	57	36	35	1
06074 V0 008	2"	35	139	81	162	260	165	48	70	45	35	1

Funzionamento valvola a L

IT

A maniglia smontata è visibile, sull'asta di manovra, un incavo a forma di L che indica il senso di esecuzione dei fori della sfera, permettendo le seguenti combinazioni:

L valve - Function

GB

With disassembled handle, an L-shaped cavity on the handling needle will show the turning way of the ports. Combinations are followings:

Funktion Winkelkugelhahn

DE

Bei abmontiertem Griff ist auf der Spindel eine L-förmige Ausparung sichtbar, welche die Laufrichtung der Kugellöcher zeigt. Folgende Kombinationen sind möglich:

Fonctionnement de la vanne en L

FR

La poignée démontable et la bille percée en L permettent les combinaisons suivantes:

Funcionamiento válvula a L

ES

Con la maneta desmontada es visible, sobre el eje de maniobra un rebaje en forma de L que indica el sentido de ejecución de los agujeros de la esfera, permitiendo las siguientes combinaciones:

Funcionamento da válvula com saída em L

PT

Com a manopla desmontada, na haste de manobra fica visível uma cavidade em forma de L, que indica o sentido de funcionamento dos orifícios da esfera, permitindo as seguintes combinações:

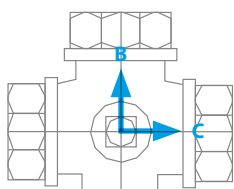

Il flusso passa da B a C (o viceversa)

Flow from B to C (or reverse)
 Der Durchfluss verläuft von B nach C (oder umgekehrt)
 Passage du fluide de B vers C (et inversement)
 El flujo pasa de B a C (o viceversa)
 O fluxo passa de B para C (ou vice-versa)

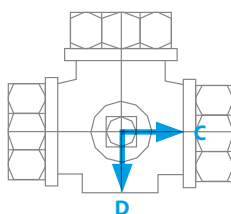

Il flusso è interrotto

Flow is stopped
 Der Durchfluss wird unterbrochen
 Passage ferme
 El flujo es interrumpido
 O fluxo é interrompido

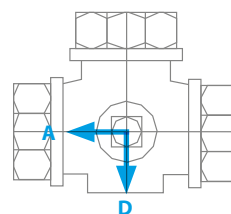

Il flusso è interrotto

Flow is stopped
 Der Durchfluss wird unterbrochen
 Passage ferme
 El flujo es interrumpido
 O fluxo é interrompido

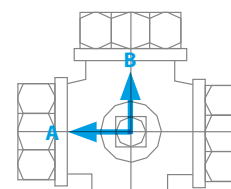

Il flusso passa da A a B (o viceversa)

Flow from A to B (or reverse)
 Der Durchfluss verläuft von A nach B (oder umgekehrt)
 Passage du fluide de A vers B (et inversement)
 El flujo pasa de A a B (o viceversa)
 O fluxo passa de A para B (ou vice-versa)

6075

VALVOLA 3 VIE A T FEMMINA G ISO 228

3 WAYS BALL VALVE "T" FEMALE G ISO 228
 3-WEGE T-KUGELHAHN INNENGEW. G ISO 228
 ROBINET 3 VOIES EN T TARAUEE G ISO 228
 VÁLVULA 3 VIAS A T HEMBRA G ISO 228
 VÁLVULA 3 VIAS EM "T" ROSCA FÊMEA G ISO 228

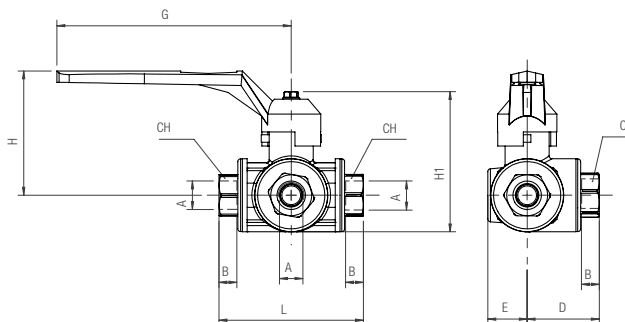

Code	A	B	H	D	L	G	H1	E	CH	DN	PN 20°/40 °C	Pack.
06075 V0 001	1/4	18	65	38,5	77	125	75	22	22	10	55	2
06075 V0 002	3/8	18	65	38,5	77	125	75	22	22	12	55	2
06075 V0 003	1/2	18	65	38,5	77	125	75	22	27	14	50	2
06075 V0 004	3/4	22	83	46	92	145	91	25	34	18	50	2
06075 V0 005	1"	23	96	52	104	170	105	30	41	23	45	2
06075 V0 006	1" - 1/4	26	102	59	118	170	115	34	50	29	35	1
06075 V0 007	1" - 1/2	30	109	69	138	170	128	40	57	36	35	1
06075 V0 008	2"	35	139	81	162	260	165	48	70	45	35	1

Funzionamento valvola a T

IT

A maniglia smontata è visibile, sull'asta di manovra, un incavo a forma di T che indica il senso di esecuzione dei fori della sfera, permettendo le seguenti combinazioni:

T valve - Function

GB

With disassembled handle, an T-shaped cavity on the handling needle will show the turning way of the ports. Combinations are following:

Funktion T-Kugelhahn

DE

Bei abmontiertem Griff ist auf der Spindel eine T-förmige Aussparung sichtbar, welche die Laufrichtung der Kugellöcher zeigt. Folgende Kombinationen sind möglich:

Funcionnement de la vanne en T

FR

La poignée démontable et la bille percée en T permettent les combinaisons suivantes:

Funcionamiento válvula a T

ES

Con la maneta desmontada es visible, sobre el eje de maniobra, un rebaje en forma de T que indica el sentido de ejecución de los agujeros de la esfera, permitiendo las siguientes combinaciones:

Funcionamento da válvula com saída em T

PT

Com a manopla desmontada é visível, na haste de manobra, uma cavidade em forma de T que indica o sentido normal de funcionamento dos furos da esfera, permitindo a as seguintes combinações:

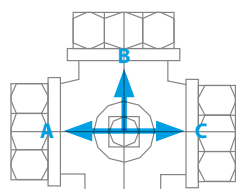

Il flusso passa in tutte le tre direzioni (A-B-C)

Flow to all directions (A-B-C)
 Der Durchfluss verläuft in alle drei Richtungen (A-B-C)
 Passage du fluide dans les trois directions (A-B-C)
 El flujo pasa en todas las tres direcciones (A-B-C)
 O fluxo passa em todas as três direções (A-B-C)

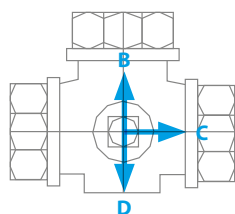

Il flusso passa solamente da B a C (o viceversa)

Flow only from B to C (or reverse)
 Der Durchfluss verläuft nur von B nach C (oder umgekehrt)
 Passage du fluide de B vers C (et inversement)
 El flujo pasa solamente de B a C (o viceversa)
 O fluxo passa somente de B para C (ou vice-versa)

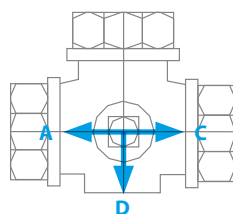

Il flusso passa solamente da A a C (o viceversa)

Flow only from A to C (or reverse)
 Der Durchfluss verläuft nur von A nach C (oder umgekehrt)
 Passage du fluide de A vers C (et inversement)
 El flujo pasa solamente de A a C (o viceversa)
 O fluxo passa somente de A para C (ou vice-versa)

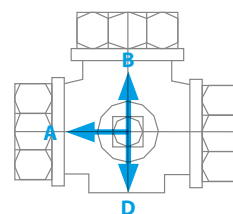

Il flusso passa solamente da A a B (o viceversa)

Flow only from A to B (or reverse)
 Der Durchfluss verläuft nur von A nach B (oder umgekehrt)
 Passage du fluide de A vers B (et inversement)
 El flujo pasa solamente de A a B (o viceversa)
 O fluxo passa somente de A para B (ou vice-versa)

New

VALVOLE A SFERA LUCCHETTABILI

**BALL VALVES LOCKABLE
KUGELHAHN BOHRUNG VERRIEGELBAR
ROBINETS CADENASSABLES
VÁLVULA DE ESFERA BLOQUEABLE
VÁLVULA ESFERA BLOQUEÁVEL**



CARATTERISTICHE TECNICHE

*TECHNICAL CHARACTERISTICS
TECHNISCHE ANGABEN
CARACTÉRISTIQUES TECHNIQUES
CARACTERÍSTICAS TÉCNICAS
CARACTERÍSTICAS TÉCNICAS*



Norma di Riferimento

- Reference standard
- Entspricht der Norm
- Norme de référence
- Normativa de referencia
- Norma de referência

PED
2014/68/UE

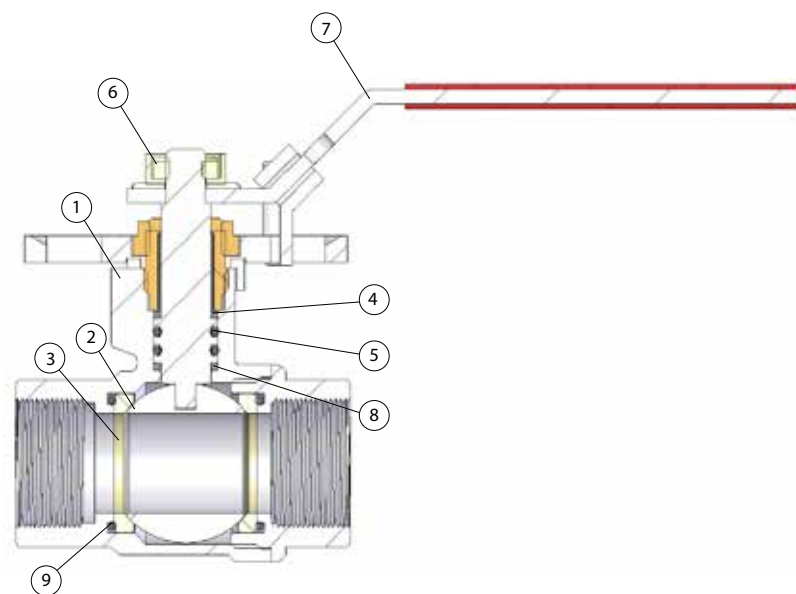

Materiali e Componenti	IT	Component Parts and Materials	GB	Komponenten und Materialien	DE
1 Corpo in ottone nichelato		1 Nickel-plated Brass Body		1 Körper Messing vernickelt	
2 Sfera in ottone nichelato		2 Nickel-plated Brass Ball		2 Kugel Messing vernickelt	
3 Sede in PTFE		3 PTFE Seats		3 Kugelsitzdichtung PTFE	
4 Boccola antigripping in PTFE		4 PTFE anti-seizing bushing		4 PTFE-Anti-Beschlagnahme-Buchsen	
5 Guarnizione in FKM		5 FKM Seal		5 FKM Dichtung	
6 Dado in ottone		6 Brass Nut		6 Messing Mutter	
7 Leva in Acciaio		7 Steel Lever Handle		7 Bedienhebel Stahl	
8 Anello antigripping in PTFE		8 PTFE anti-seizing ring		8 PTFE-Anti-Beschlagnahme-Ring	
*9 Guarnizione		*9 Seal		*9 Dichtung	

Matériaux et Composants	FR	Materiales y Componentes	ES	Materiais e Componentes	PT
1 Corps: laiton nickelé		1 Cuerpo en latón niquelado		1 Corpo em Latão Niquelado	
2 Bille: laiton nickelé		2 Esfera en latón niquelado		2 Esfera em Latão Niquelado	
3 Joint de fronde: PTFE		3 Junta sede esfera PTFE		3 Vedação da sede da esfera em PTFE	
4 Douille anti-gripping de PTFE		4 Buje anti-que agarra de PTFE		4 Bucha anti-apreensão de PTFE	
5 Joint en FKM		5 Junta en FKM		5 Vedações em FKM	
6 Ecrou en laiton		6 Tuerca en latón		6 Porca em Latão	
7 Poignée en acier		7 Leva de maniobra en acero		7 Manopla de manobra em aço	
8 Bague anti-gripping PTFE		8 Anillo anti-que agarra de PTFE		8 Anel anti-apreensão de PTFE	
*9 Joint		*9 Junta		*9 Vedações	

* = Non presente nelle misure 3/8 e 1/2
 Not present in 3/8 and 1/2
 Nicht anwesend in 3/8 und 1/2
 Non présent en 3/8 et 1/2
 No presente en 3/8 y 1/2
 Não presente em 3/8 e 1/2



Temperature
 Temperatures
 Temperatur
 Températures
 Temperaturas
 Temperaturas

- 10 °C
 + 100 °C



Fluidi compatibili
 Aria compressa / Vuoto / Acqua / Oli
Fluids
 Compressed air / Vacuum / Water / Oils
Geeignete Medien
 Druckluft / Vakuum / Wasser / Oel

Fluides compatibles
 Air comprimé / Vide / Eau / Huile

Fluidos compatibles
 Aire comprimido / Vacío / Agua / Aceite

Fluidos compativeis
 Ar comprimido / Vácuo / Água / Óleos



Filettatura Gas cilindrica conforme ISO 228 Classe A.	IT	Threads Parallel gas in conformity with ISO 228 Class A.	GB	Gewindearten Zylindrisches Gewinde nach Norm ISO 228 Classe A.	DE
Filetages Filetage cylindrique conforme: ISO 228 Classe A.	FR	Roscas Gas cilindrica conforme ISO 228 Clase A.	ES	Roscas Gas paralela conforme ISO 228 Classe A.	PT

6750L

VALVOLA A SFERA FEMMINA LUCCHETTABILE
 BALL VALVES FEMALE LOCKABLE
 KUGELHAHN BOHRUNG INNENGEW. VERRIEGELBAR
 ROBINET FEMELLE CADENASSABLE
 VÁLVULA DE ESFERA HEMBRA BLOQUEABLE
 VÁLVULA ESFERA FÊMEA BLOQUEÁVEL

Code	A	L	DN	F	H	G	PN	Pack.
06750 L0 001	3/8	45.5	10	11.5	71	120	40	2
06750 L0 002	1/2	55.5	15	14	74	120	40	2
06750 L0 003	3/4	66	20	16	76.5	120	40	2
06750 L0 004	1"	75	25	17	81	120	40	2
06750 L0 005	1 1/4	85	32	18	99.5	166	40	2
06750 L0 006	1 1/2	99.5	39	19	102.5	166	40	2
06750 L0 007	2"	115	48	21	109	166	40	2

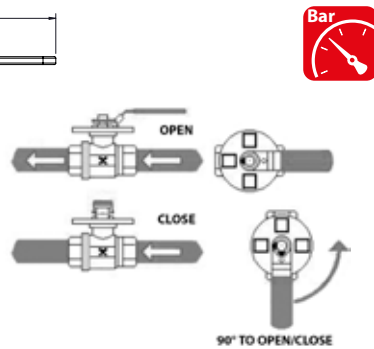
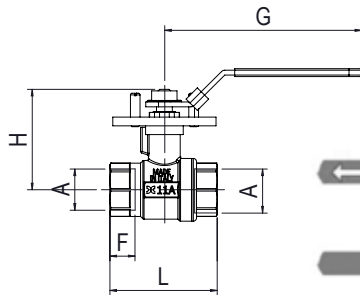

Pressioni
 Pressures
 Druckbereich
 Pressions
 Presiones
 Pressões

MAX 40 bar



Diagramma Perdite di carico
 Pressure drop diagram
 Druckverlust diagramm
 Diagramme Perte de charge
 Diagrama Pérdida de carga
 Diagrama Queda de pressão

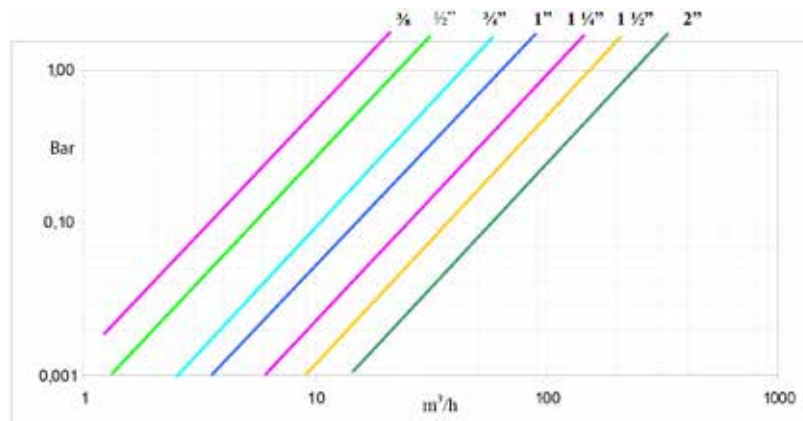

**COEFFICIENT K V
 COEFFICIENTE K V**

Ø	Kv
3/8"	16
1/2"	23
3/4"	43
1"	63
1 1/4"	105
1 1/2"	170
2"	250

6755L

VALVOLA CON FORO DI SFIATO FEMMINA LUCCHETTABILE

EXHAUST BALL VALVE LOCKABLE
 KUGELHAHN AUS VERNICKELTEM MESSING MIT BOHRUNG FÜR DEKOMPRESSION
 ROBINET AVEC PURGE
 VÁLVULA HEMBRA CON AGUJERO DE DESCOMPRESIÓN
 VÁLVULA ROSCA FÊMEA COM FURO DA DESCOMPRESSÃO

Code	A	L	DN	F	H	G	PN	Pack.
06755 L0 001	3/8	45.5	8	14	71	120	16	2
06755 L0 002	1/2	55.5	10	14	74	120	16	2
06755 L0 003	3/4	68	15	16	76.5	120	16	2
06755 L0 004	1"	78	20	17	81	120	16	2
06755 L0 005	1 1/4	90	32	18	99.5	166	16	2
06755 L0 006	1 1/2	100	39	19	102.5	166	16	2
06755 L0 007	2"	115	48	21	109	166	16	2

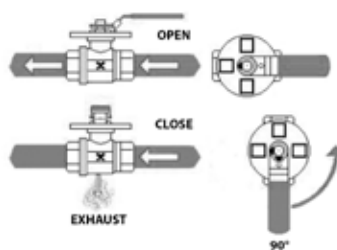
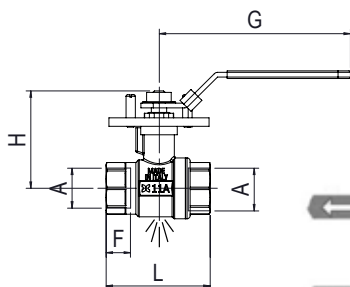

Pressioni

Pressures

Druckbereich

Pressions

Presiones

Pressões

**MAX
16 bar**



Diagramma Perdite di carico

Pressure drop diagram

Druckverlust diagramm

Diagramme Perte de charge

Diagrama Pérdida de carga

Diagrama Queda de pressão

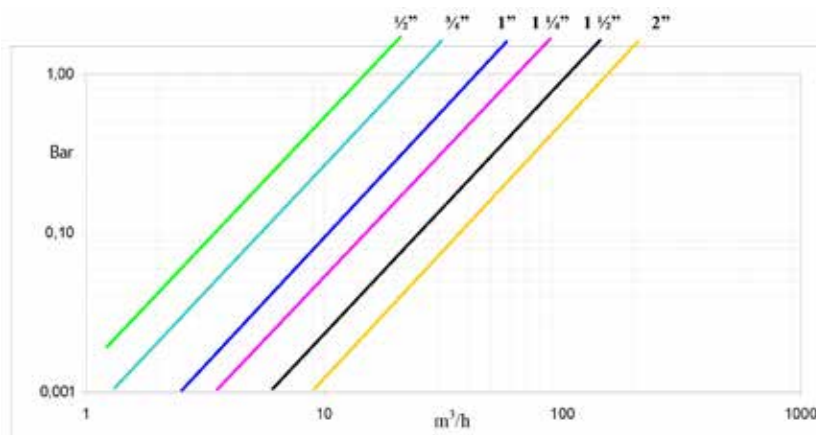

COEFFICIENT K V COEFFICIENTE K V

Ø	Kv
1/2"	16
3/4"	23
1"	43
1 1/4	64
1 1/2	110
2"	160

6760L

VALVOLA A 3 VIE A "L" FEMMINA LUCCHETTABILE

3 WAYS BALL VALVE "L" FEMALE LOCKABLE
 3-WEGE WINKEL-KUGELHAHN INNENGEW.
 ROBINET EQUERRE 3 VOIES
 VÁLVULA 3 VIAS A L HEMBRA
 VÁLVULA 3 VIAS EM "L" ROSCA FÊMEA

Code	A	L	DN	F	H	G	PN	Pack.
06760 L0 002	1/2	56	10	14	61.5	120	25	2
06760 L0 003	3/4	68	15	16	65	120	25	2
06760 L0 004	1"	78	20	17	69	120	25	2
06760 L0 005	1 1/4	90	25	18	74	120	25	2
06760 L0 006	1 1/2	100	32	19	80	120	25	2
06760 L0 007	2"	115	40	21	86	120	25	1
06760 L0 008	3"	180	68	25	132	246	25	1

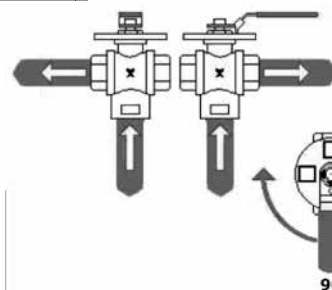
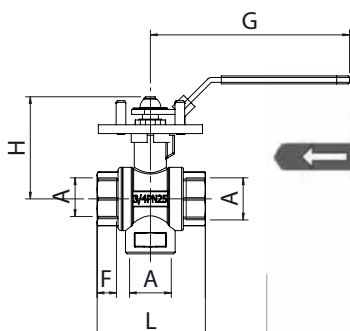

Pressioni

Pressures

Druckbereich

Pressions

Presiones

Pressões

**MAX
25 bar**

6765L

VALVOLA A 3 VIE A "T" FEMMINA LUCCHETTABILE

3 WAYS BALL VALVE "T" FEMALE LOCKABLE
 3-WEGE T-KUGELHAHN INNENGEW.
 ROBINET 3 VOIES EN T TARAUDEE
 VÁLVULA 3 VIAS A T HEMBRA
 VÁLVULA 3 VIAS EM "T" ROSCA FÊMEA

Code	A	L	DN	F	H	G	PN	Pack.
06765 L0 002	1/2	56	10	14	61.5	120	25	2
06765 L0 003	3/4	68	15	16	65	120	25	2
06765 L0 004	1"	78	20	17	69	120	25	2
06765 L0 005	1"1/4	90	25	18	74	120	25	2
06765 L0 006	1"1/2	100	32	19	80	120	25	2
06765 L0 007	2"	115	40	21	86	120	25	1
06765 L0 008	3"	180	68	25	132	246	25	1

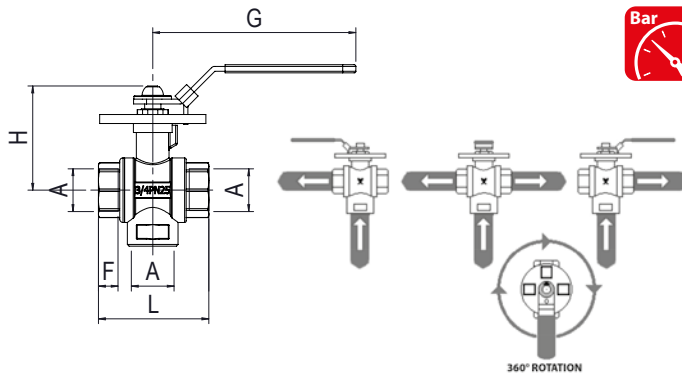

Pressioni
 Pressures
 Druckbereich
 Pressions
 Presiones
 Pressões

**MAX
 25 bar**



Diagramma Perdite di carico

Pressure drop diagram
 Druckverlust diagramm
 Diagramme Perte de charge
 Diagrama Pérdida de carga
 Diagrama Queda de pressão

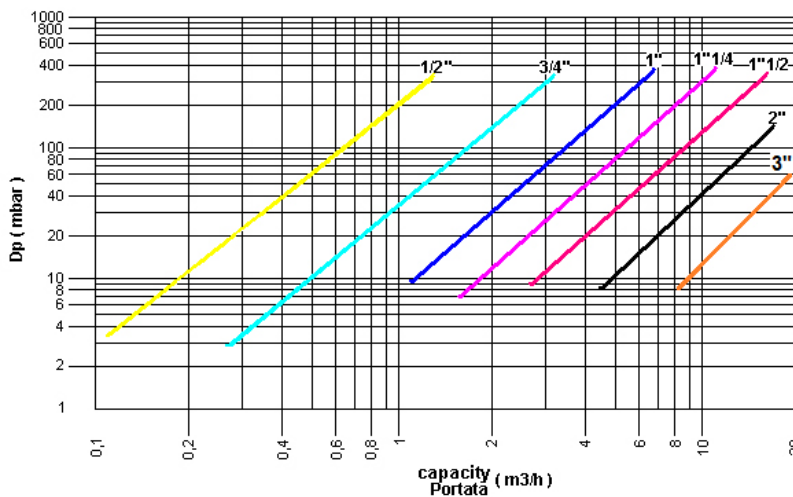

COEFFICIENT K V

Ø	Kv
1/2"	2,27
3/4"	5,5
1"	10,76
1"1/4	17,26
1"1/2	24,97
2"	45,09
3"	105

LUC010002

LUCCHETTO IN OTTONE MM 40

BRASS PADLOCK MM40
 MESSINGSCHLÖSSER MM40
 CADENAS EN LAITON MM40
 CANDADO DE LATÓN MM40
 CADEADO DE BRONZE MM40

Code	Ø	Pack.
LUC01 00 002	6	1



FILTRO A Y

Y FILTER
Y FILTER
FILTRE Y
FILTRO A Y
FILTRO Y

Materiali e Componenti	IT	Component Parts and Materials	GB	Komponenten und Materialien	DE
<ul style="list-style-type: none"> Corpo in ottone dal 1/4 al 2" Corpo in bronzo dal 2"1/2 al 4" Tappo in ottone Filtro in acciaio AISI 304 Guarnizione corpo in NBR 		<ul style="list-style-type: none"> Brass body from 1/4 to 2" Bronze body from 2"1/2 to 4" Brass Cap Steel AISI 304 Strainer NBR Body Seal 		<ul style="list-style-type: none"> Körper Messing von 1/4 bis 2" Körper Bronze von 2"1/2 bis 4" Verschlussdeckel Messing Filter Edelstahl AISI 304 Körperdichtung NBR 	
Matériaux et Composants	FR	Materiales y Componentes	ES	Materiais e Componentes	PT
<ul style="list-style-type: none"> Corps en laiton de 1/4 à 2" Corps en bronze de 2"1/2 à 4" Bouchon en laiton Filtre inox AISI 304 Joint de corps: NBR 		<ul style="list-style-type: none"> Cuerpo en latón de 1/4 a 2" Cuerpo en Bronce 2"1/2 a 4" Tapón en latón Filtro en acero AISI 304 Junta cuerpo en NBR 		<ul style="list-style-type: none"> Corpo em latão de 1/4 al 2" Corpo em bronze de 2"1/2 al 4" Tampão em latão Filtro em aço AISI 304 Vedação corpo em NBR 	

Pressione massima
Maximum Pressure
Maximaler Betriebsdruck
Pression maximum
Presión máxima
Pressão máxima
1/4 ÷ 2"
20 bar
2" - 1/2 ÷ 4"
16 bar

Temperatura di esercizio in assenza di vapore
Working temperature without steam
Betriebstemperatur ohne Dampf
Température d'utilisation sans vapeur
Temperatura de ejercicio con ausencia de vapor
Temperatura de trabalho sem presença de vapor
- 20 °C
+ 110 °C

Soglia di filtrazione
Filtration degree
Filterfeinheit
Degré de filtration
Grado de filtración
Grau de filtragem
1/4 ÷ 2"
500 µm
2"1/2 - 3" - 4"
800 µm

Fluidi compatibili
Acqua / Oli / Aria
Fluids
Water / Oils / Air
Geeignete Medien
Wasser / Oel / Air
Fluides compatibles
Eau / Huile / Air
Fluidos compatibles
Agua / Aceite / Aire
Fluidos compatíveis
Água / Óleo / Ar

Filettatura
Gas cilindrica conforme ISO 228 Classe A.
Threads
Parallel gas in conformity with ISO 228 Class A.
Gewindearten
Zylindrisches Gewinde nach Norm ISO 228 Classe A.
Filetages
Filetage cylindrique conforme: ISO 228 Class A.
Roscas
Gas cilindrica conforme ISO 228 Classe A.
Roscas
Gas paralela conforme ISO 228 Classe A.



Diagramma Perdite di carico

Pressure drop diagram

Druckverlust diagramm

Diagramme Perte de charge

Diagrama Pérdida de carga

Diagrama Queda de pressão

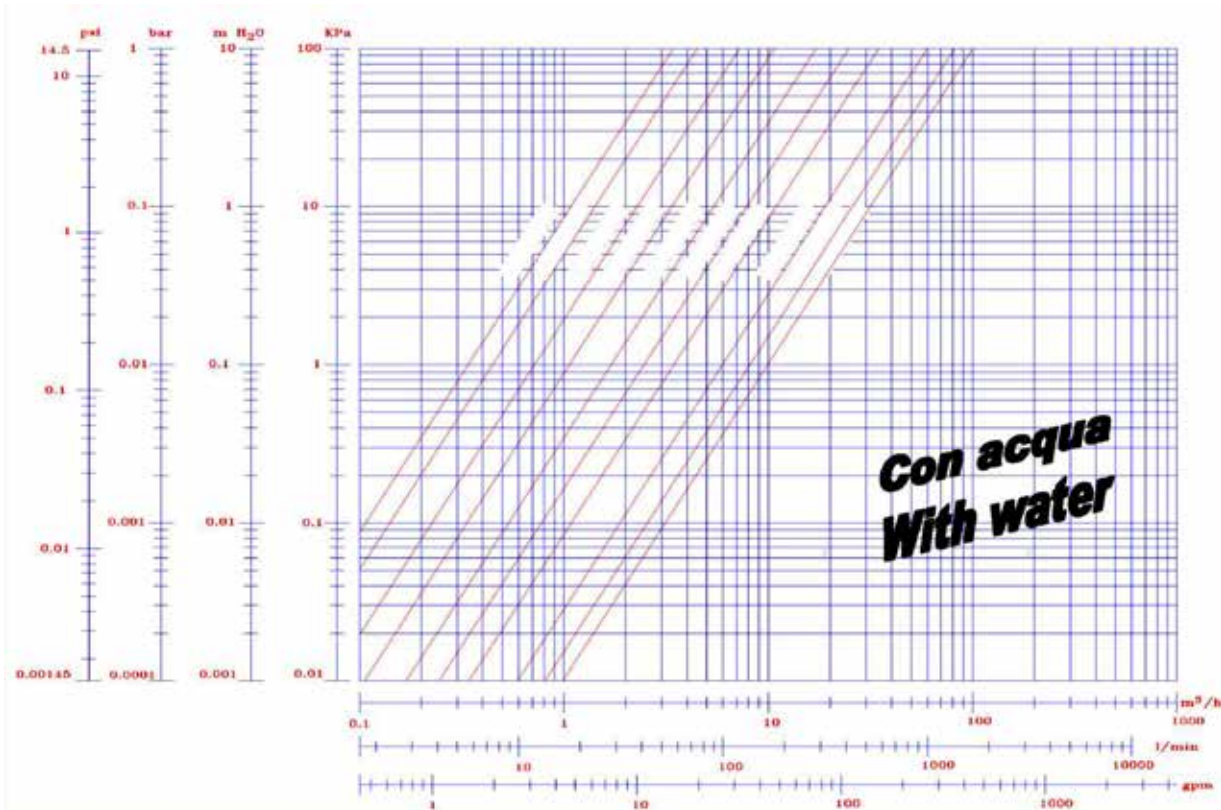

6035

FILTRO "Y"

"Y" FILTER

"Y" FILTER

FILTRE "Y"

FILTRO "Y"

FILTR

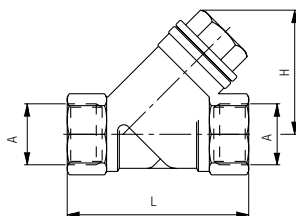

Code	A	DN	L	H	PN	KV	Pack.
06035 00 001	1/4	8	55	40	20	2,2	10
06035 00 002	3/8	10	55	40	20	3,4	10
06035 00 003	1/2	15	58	40	20	4,5	10
06035 00 004	3/4	20	70	50	20	7,9	10
06035 00 005	1"	25	87	56	20	11	5
06035 00 006	1"1/4	32	96	64	20	16	2
06035 00 007	1"1/2	40	106	73	20	22	2
06035 00 008	2"	50	126	89	20	35	1
06035 00 009	2"1/2	65	150	107	16	60	1
06035 00 010	3"	80	170	120	16	83	1
06035 00 011	4"	100	219	161	16	100	1

VALVOLE DI RITEGNO

NO RETURN VALVE
RÜCKSCHLAGVENTIL
CLAPET ANTI-RETOUR
VÁLVULA DE RETENCIÓN
VÁLVULAS ANTI-RETORNO



CARATTERISTICHE TECNICHE

TECHNICAL CHARACTERISTICS
TECHNISCHE ANGABEN
CARACTÉRISTIQUES TECHNIQUES
CARACTERÍSTICAS TÉCNICAS
CARACTERÍSTICAS TÉCNICAS



Norma di Riferimento

Reference standard
Entspricht der Norm
Norme de référence
Normativa de referencia
Norma de referência

1907/2006 REACH ✓	2011/65/CE RoHS ✓
PED 2014/68/UE	SILICON FREE

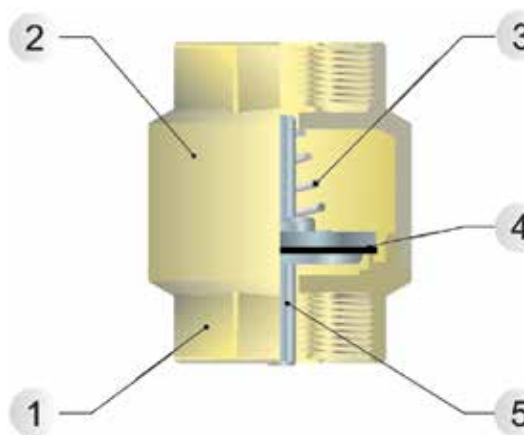

Materiali e Componenti	IT	Component Parts and Materials	GB	Komponenten und Materialien	DE
1 Corpo in Ottone 2 Coperchio in Ottone 3 Molla in acciaio inox 4 Guarnizione in NBR 5 Otturatore in plastica		1 Brass Body 2 Brass Cover Cap 3 Stainless steel Spring 4 NBR Seal 5 Plastic Shutter		1 Körper Messing 2 Einschraubkörper Messing 3 Feder Edelstahl 4 Dichtung NBR 5 Verschluss Kunststoff	
Matériaux et Composants	FR	Materiales y Componentes	ES	Materiais e Componentes	PT
1 Corps: laiton 2 Corps: laiton 3 Ressort: inox 4 Joint: NBR 5 Obturateur: plastique		1 Cuerpo en latón 2 Cuerpo en latón 3 Muelle en Acero Inox 4 Junta en NBR 5 Obturador en material plástico		1 Corpo em Latão 2 Cobertura em Latão 3 Mola em aço inox 4 Vedação em NBR 5 Obturador em plástico	



Pressioni

Pressures
Druckbereich
Pressions
Presiones
Pressões

DN	
3/8 ÷ 1"	1"-1/4 ÷ 2"
12 bar	10 bar



Temperature

Temperatures
Temperatur
Temperatur
Temperaturas
Temperaturas

0 °C
+ 90 °C



Fluidi compatibili

Aria compressa / Acqua / Oli

Fluids
Compressed air / Water / Oils

Geeignete Medien
Druckluft / Wasser / Oel

Fluides compatibles
Air comprimé / Eau / Huile

Fluidos compatibles
Aire comprimido / Agua / Aceite

Fluidos compatíveis
Ar comprimido / Água / Óleo

6036

VALVOLA DI RITEGNO
 NON RETURN VALVE
 RÜCKSCHLAGVENTIL
 CLAPET ANTI-RETOUR
 VÁLVULA DE RETENCIÓN
 VÁLVULA ANTI-RETORNO

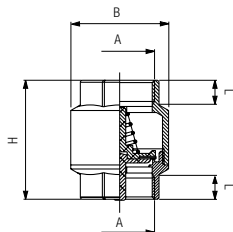

Code	A	H	L	B	Pack.
06036 00 007	3/8	49	11	34	10
06036 00 001	1/2	49	11	34	10
06036 00 002	3/4	54	11	42	5
06036 00 003	1"	59	11,5	48	5
06036 00 004	1"1/4	67	14,5	60	2
06036 00 005	1"1/2	72	14,5	69	2
06036 00 006	2"	77	14,5	85	1



Pressioni

- Pressures
- Druckbereich
- Pressions
- Presiones
- Pressões

A	mbar
3/8	-
1/2	24,5
3/4	27,1
1"	19,4
1"1/4	34,5
1"1/2	15,9
2"	10,8

6037

VALVOLA DI FONDO
 FINAL VALVE
 ENDVENTIL
 CLAPET ANTI RETOUR DE FIN DE LIGNE
 VÁLVULA DE FONDO
 VÁLVULA DE FUNDO

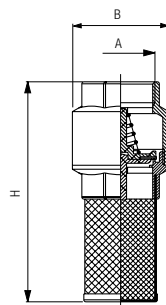

Code	A	H	B	Pack.
06037 00 001	1/2	81	34	10
06037 00 002	3/4	87	42	5
06037 00 003	1"	97	48	5
06037 00 004	1"1/4	110	60	4
06037 00 005	1"1/2	125	69	2
06037 00 006	2"	145	85	1



Soglia di filtrazione - Filtration threshold - Filterfeinheit
 Capacité de filtration - Grado de filtración - Limite de filtragem

1.000 µm

6038

FILTRO IN RETE STIRATA IN AISI 304
 AISI 304 STRECHED NET FILTER
 NETZFILTER AUS AISI 304
 FILTRE EN AISI 304
 FILTRO DE MALLA EN AISI 304
 FILTRO DE TELA PARA VÁLVULA DE FUNDO EM AISI 304

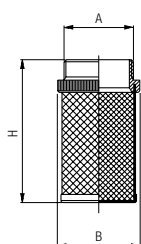

Code	A	H	B	Pack.
06038 00 002	1/2	50	28	10
06038 00 003	3/4	56	33	5
06038 00 004	1"	58	41	5
06038 00 005	1"1/4	69	50	5
06038 00 006	1"1/2	78	55	5
06038 00 007	2"	96	67	1



Soglia di filtrazione - Filtration threshold - Filterfeinheit
 Capacité de filtration - Grado de filtración - Limite de filtragem

1.000 µm

