



57000

Серия 57000

ЦАНГОВЫЕ ФИТИНГИ С МЕТАЛЛИЧЕСКИМ ДЕМОНТАЖНЫМ КОЛЬЦОМ
PUSH-IN FITTINGS WITH METAL COLLET

Технические характеристики / Technical Characteristics

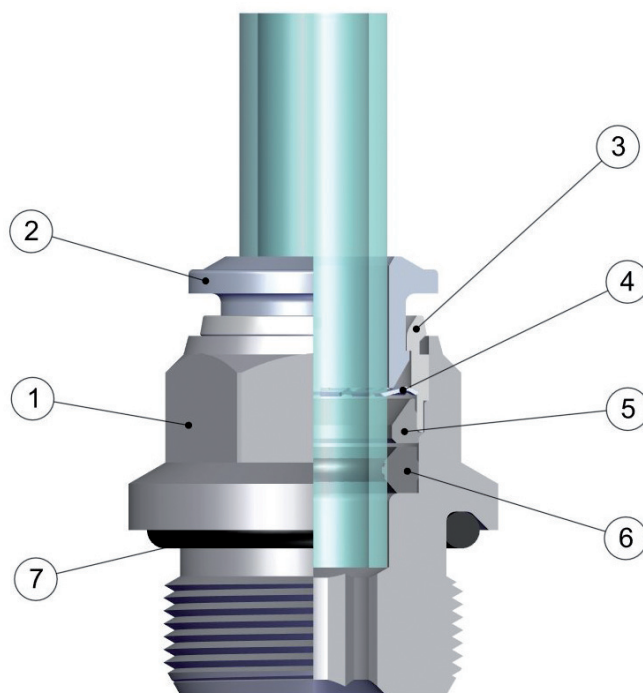

FKM или EPDM
по запросу
IF REQUESTED
FKM OR EPDM

Части и материалы / Component Parts and Materials

1 Никелированный латунный корпус	1 Nickel-plated brass Body
2 Никелированное латунное демонтажное кольцо	2 Nickel-plated brass Collet
3 Никелированная латунная фиксирующая втулка	3 Nickel-plated brass Capsule
4 Цанга из нержавеющей стали	4 Steel aisi 301 Clamping washer
5 Технополимерное опорное кольцо	5 Technopolymeric Safety ring
6 Уплотнение NBR (FKM или EPDM по запросу)	6 Nbr Lip seal (if requested FKM)
7 Уплотнение из NBR (FKM или EPDM по запросу)	7 Nbr Thread packing (if requested FKM)

Давление / Pressures

Минимальное давление / Minimum pressure: -0.99 bar (-0.099 MPa)
Максимальное давление / Maximum pressure: 15 bar (1.5 MPa)

Резьбы / Threads

Коническая резьба "short"
"Short" taper thread.
Коническая ISO 7.1, BS 21, DIN 2999
Tapered gas in conformity with ISO7.1, BS 21, DIN 2999.
Цилиндрическая ISO 228 Classe A
Parallel gas in conformity with ISO 228 Class A.

Соединяемые трубки / Connection Tubes

Пластиковые трубки:
PA6, PA11, PA12, Полиэтилен, *Полиуретан, PTFE, FEP.
*Для полиуретановых труб требуется минимальная твердость 98 shore.
Plastic tubes:
PA6, PA11, PA12, Polyethylene, *Polyurethane, PTFE, FEP.
*For Polyurethane hoses it is required a minimum hardness of

Температура / Temperatures

Минимальная температура / Minimum temperature: -20 °C
Максимальная температура / Maximum temperature: +80 °C

Для уплотнений из FKM / With FKM Seals

Минимальная температура / Minimum temperature: -15 °C
Максимальная температура при продолжительной работе:
Maximum temperature in continuos: +130 °C
Максимальная температура при кратковременной работе:
Maximum temperature for short term: +185 °C

Con Guarnizioni EPDM / With EPDM Seals

Минимальная температура / Minimum temperature: -40 °C
Максимальная температура при продолжительной работе:
Maximum temperature in continuos: +130 °C
Максимальная температура при кратковременной работе:
Maximum temperature for short term: +160 °C

Рабочая среда / Fluids

Сжатый воздух / Compressed air.
Вакуум / Vacuum
Вода / Water
Пар / Steam

Резьбы / Threads

Коническая резьба "short" была разработана что бы получить следующие преимущества:

- уменьшить общую длину
- меньший размер под гаечный ключ в сочетании с цилиндрической резьбой
- возможность соединения с разными внутренними резьбами как с конической так и цилиндрической

The "short" taper thread has been designed to offer the following advantages to the users:

- reduced overall length;
- smaller hex dimensions compared to the parallel threads;
- to allow the assembly with different female threads both taper as well as parallel;

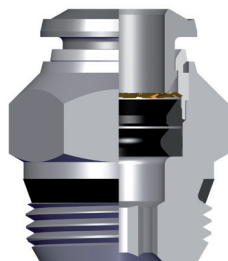

NPT
NPTF

Коническая
Tapered

ISO 7
BSPP

Цилиндрическая
Parallell

ISO 7
BSPT
PT

Коническая
Tapered

ISO 228
BSP
PF

Цилиндрическая
Parallell

Обеспечивает хорошую герметичность с необработанными поверхностями, без фасок и с фасками разных видов и разных размеров.

To ensure the right tightening also with surfaces not perfectly flat, without spot-facing, concave convex and with different kinds of chamfers or radius.

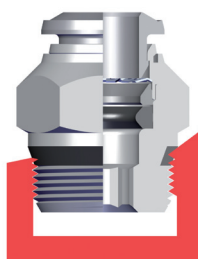

Скошенный
Inclined

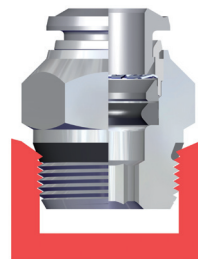

Внутренняя фаска
Concave

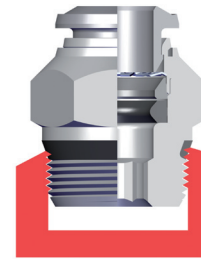

Внешняя фаска
Convex

Таблица крутящих моментов / Torque specifications

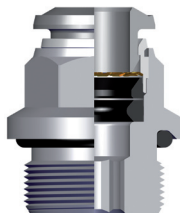

COPPIE DI SERRAGGIO PER FILETTATURE MASCHIO ISO-228 CON OR
TORQUE TO MALE THREADS ISO-228 WITH OR

MISURA MEASURE	COPPIA CONSIGLIATA Nm RECOMMENDED TORQUE Nm	COPPIA DI ROTTURA Nm BREAKING TORQUE Nm
M5	0,08	0,32
1/8	3	8
1/4	9	30
3/8	10	60
1/2	12	50

I VALORI DI ROTTURA POSSONO VARIARE IN BASE ALL'ARTICOLO
BREAKING VALUES MAY VARY ACCORDING TO THE ITEM

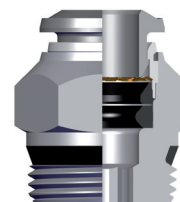

COPPIE DI SERRAGGIO PER FILETTATURE MASCHIO "SHORT"
TORQUE TO MALE THREADS "SHORT"

MISURA MEASURE	COPPIA MINIMA CONSIGLIATA Nm RECOMMENDED MINIMUM TORQUE Nm	COPPIA MASSIMA CONSIGLIATA Nm RECOMMENDED MAX TORQUE Nm
1/8	5	7
1/4	5	7
3/8	5	7
1/2	5	7

I VALORI DI ROTTURA POSSONO VARIARE IN BASE ALL'ARTICOLO
BREAKING VALUES MAY VARY ACCORDING TO THE ITEM

Все резьбы этой серии (также M5) укомплектованы уплотнениями, которые уже установлены на фитинги, что позволяет сократить время монтажа.

All of threads from this range (also the M5), have been equipped with tightening parts which allow the direct assembly of the fittings, reducing the installation time.

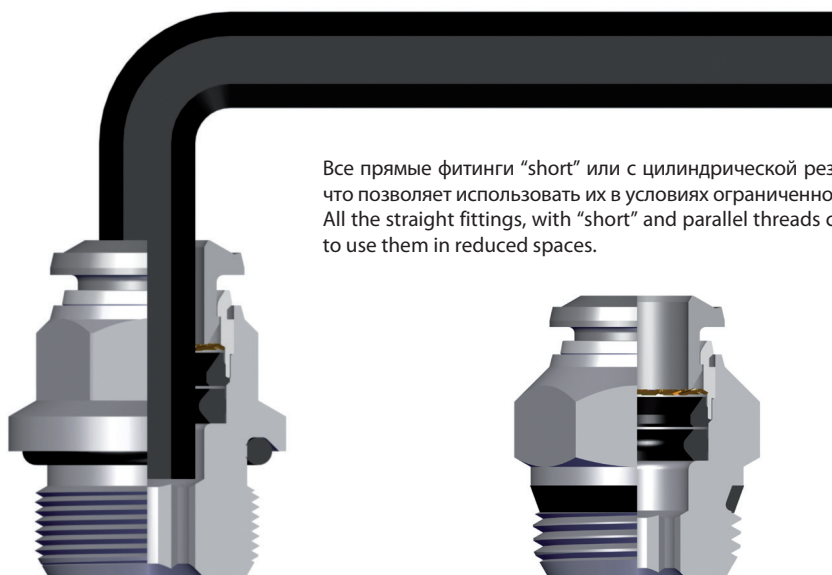
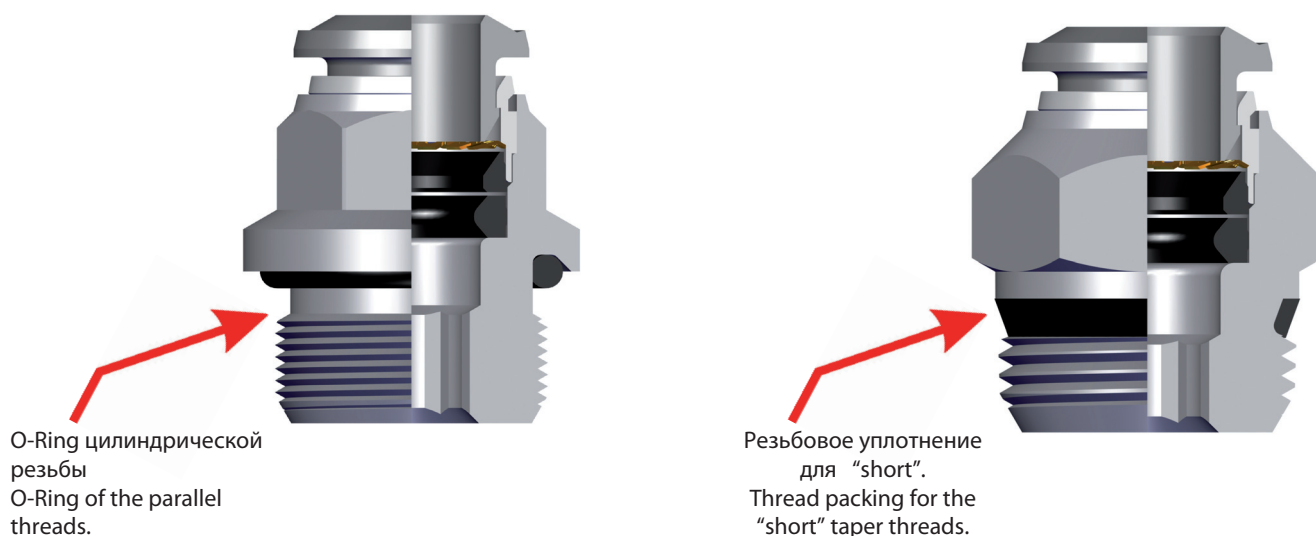

Все прямые фитинги "short" или с цилиндрической резьбой могут монтироваться с помощью гаечного ключа, что позволяет использовать их в условиях ограниченного пространства.

All the straight fittings, with "short" and parallel threads can be assembled also with Allen wrench and it is possible to use them in reduced spaces.

Цанга / Clamping washer

Цанга сделана из нержавеющей стали, и обеспечивает отличный зажим трубы из любого материала без повреждения поверхности.

The washer is made in stainless steel ensures the perfect tube clamping with every Kinds of materials without damage the surface.

Соединение между трубкой и фитингом обеспечивает полную герметичности даже при ударах и вибрации

The connection between the tube and the fitting ensure a total tightness even in severe conditions such as impact and vibrations.

Специальная форма уплотнения обеспечивает герметичность даже в вакууме.

The particular geometric shape of the seal ensure the perfect tightness even with vacuum.

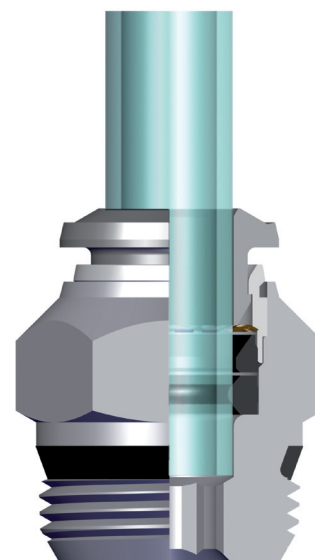

57000

ПРЯМОЕ СОЕДИНЕНИЕ С ВНЕШНЕЙ РЕЗЬБОЙ (SHORT) - STRAIGHT MALE ADAPTOR (SHORT)

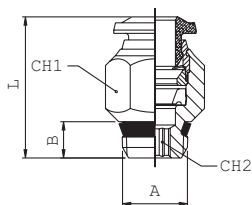

Код Code	Трубка Tube	A	B	L	CH1	CH2	Упак. Pack.
*8900000003	4 (5/32)	1/8	5.5	18	11	3	10
*8900000004	4 (5/32)	1/4	7	19	14	3	10
5700000002	6	1/8	5.5	21.5	13	4	10
5700000003	6	1/4	7	21	14	4	10
5700000014	6	3/8	7.5	23	17	4	10
5700000015	6	1/2	9	23.5	21	4	10
*8900000008	8 (5/16)	1/8	5.5	24.5	14	5	10
*8900000009	8 (5/16)	1/4	7	22	14	6	10
*8900000010	8 (5/16)	3/8	7.5	23	17	6	10
*8900000022	8 (5/16)	1/2	9	23.5	21	6	10
5700000007	10	1/4	7	28	17	7	10
5700000008	10	3/8	7.5	25.5	17	8	10
5700000017	10	1/2	9	26	21	8	10
5700000009	12	1/4	7	31.5	20	7	10
5700000010	12	3/8	7.5	29.5	20	9	10
5700000018	12	1/2	9	31.5	21	10	10
5700000019	14	3/8	7.5	32.5	21	9	10
5700000020	14	1/2	9	31.5	21	10	10

*Фитинги серии 89000 для дюймовых труб

* Items in common with series 89000 for inch tubes

57010

ПРЯМОЕ СОЕДИНЕНИЕ С ВНЕШНЕЙ РЕЗЬБОЙ (SHORT) - STRAIGHT MALE ADAPTOR (SHORT) WITH EXAGON EMBEDDED

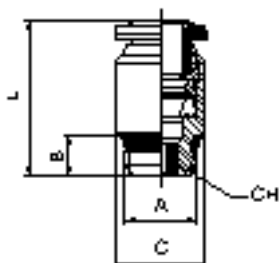

Код Code	Трубка Tube	A	B	C	L	CH	Упак. Pack.
*8901000001	4 (5/32)	1/8	7.5	10	19	3	10
5701000003	6	1/8	7.5	12	22.5	4	10
5701000004	6	1/4	11	14	24.5	4	10
*8901000002	8 (5/16)	1/8	7.5	14	25.5	5	10
*8901000003	8 (5/16)	1/4	11	14	25	6	10

* Фитинги серии 89000 для дюймовых труб

* Items in common with series 89000 for inch tubes

57010

ПРЯМОЕ СОЕДИНЕНИЕ С НАРУЖНОЙ РЕЗЬБОЙ (ЦИЛИНДРИЧЕСКАЯ) - STRAIGHT MALE ADAPTOR PARALLEL WITH EXAGON EMBEDDED

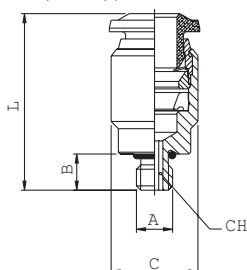

Код Code	Трубка Tube	A	B	C	L	CH	Упак. Pack.
5701000001	4	M5	4	10	21	2.5	10
5701000009	4	M7x1	5	10	21	2.5	10
5701000007	6	M5	4	12	24.5	2.5	10

57020

ПРЯМОЕ СОЕДИНЕНИЕ С НАРУЖНОЙ РЕЗЬБОЙ (ЦИЛИНДРИЧЕСКАЯ) - STRAIGHT MALE ADAPTOR (PARALLEL)

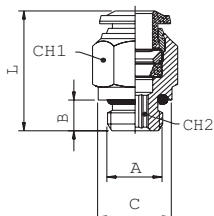

Код Code	Трубка Tube	A	B	C	L	CH1	CH2	Упак. Pack.
5702000001	4	M5	4	8	21	10	2	10
5702000002	4	1/8	6	13	20	10	3	10
5702000022	4	1/4	8	16	19.5	16	3	10
5702000018	5	M5	4	8	23.5	12	2	10
5702000019	5	1/8	6	13	22	12	4	10
5702000020	6	M5	4	10	24.5	13	2	10
5702000003	6	1/8	6	13	23.5	13	4	10
5702000004	6	1/4	8	16	23.5	13	4	10
5702000027	6	3/8	9	20	25	13	4	10
5702000028	6	1/2	10	25	27	13	4	10
5702000005	8	1/8	6	13	25	14	5	10
5702000006	8	1/4	8	16	23	14	6	10
5702000007	8	3/8	9	20	24	14	6	10
5702000029	8	1/2	10	25	26.5	14	6	10
5702000008	10	1/4	8	16	30.5	17	6	10
5702000009	10	3/8	9	20	27.5	17	8	10
5702000031	10	1/2	10	25	27	17	8	10
5702000032	12	1/4	8	16	34.5	20	6	10
5702000011	12	3/8	9	20	34	20	8	10
5702000023	12	1/2	10	25	31	22	10	10
5702000024	14	3/8	9	20	35	21	10	10
5702000025	14	1/2	10	25	32	22	10	10
5702000012	6	M12x1	8	15	23.5	13	4	10
5702000013	6	M12x1.25	8	15	23.5	13	4	10
5702000014	6	M12x1.5	8	15	23.5	13	4	10
5702000017	8	M12x1.5	8	15	27.5	14	6	10

57030

ПРЯМОЕ СОЕДИНЕНИЕ ВНУТРЕННЯЯ РЕЗЬБА - STRAIGHT FEMALE ADAPTOR

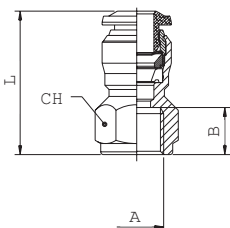

Код Code	Трубка Tube	A	B	L	CH	Упак. Pack.
5703000008	4	M5	5.5	21	11	10
5703000001	4	1/8	8.5	24	13	10
5703000009	4	1/4	11	27.5	16	10
5703000006	5	1/8	8.5	26.5	13	10
5703000002	6	1/8	8.5	26	13	10
5703000003	6	1/4	11	29.5	16	10
5703000004	8	1/8	8.5	27	15	10
5703000005	8	1/4	11	29.5	17	10
5703000010	8	3/8	12	32	19	10
5703000011	10	1/4	11	32	18	10
5703000012	10	3/8	12	33.5	19	10
5703000013	10	1/2	15	39	24	10
5703000014	12	3/8	12	36	21	10
5703000015	12	1/2	15	41	24	10

57040

ПРЯМОЕ СОЕДИНЕНИЕ - STRAIGHT CONNECTOR

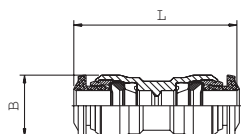

Код Code	Трубка Tube	Трубка Tube	L	B	Упак. Pack.
*5704000001	4 (5/32)		30.5	10.5	10
5704000008	5		33	11.5	10
5704000002	6	4	32	12.5	10
5704000003	6		34	12.5	10
5704000004	8	6	35	14.5	10
*5704000005	8 (5/16)		36	14.5	10
5704000011	10	8	40.5	17.5	10
5704000006	10		42	17.5	10
5704000012	12	10	45.5	20.5	10
5704000007	12		47	20.5	10
5704000010	14		49	21.5	10

*Фитинги серии 89000 для дюймовых труб
 * Items in common with series 89000 for inch tubes

57050

ПЕРЕБОРОЧНОЕ СОЕДИНЕНИЕ - BULKHEAD CONNECTOR

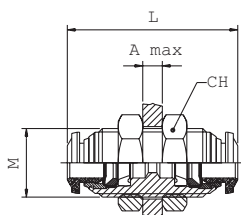

Код Code	Трубка Tube	M	L	CH	A max	Упак. Pack.
*5705000001	4 (5/32)	M12x1	31.5	17	7	10
5705000006	5	M14x1	33	17	7	10
5705000002	6	M14x1	35	17	9.5	10
*5705000003	8 (5/16)	M16x1	37	19	10.5	10
5705000004	10	M20x1	43	24	12.5	10
5705000005	12	M22x1	48	26	16.5	10

*Фитинги серии 89000 для дюймовых труб
* Items in common with series 89000 for inch tubes

57100

УГЛОВОЕ СОЕДИНЕНИЕ НАРУЖНЯЯ РЕЗЬБА (КОНИЧЕСКАЯ) - ELBOW MALE ADAPTOR (TAPER)

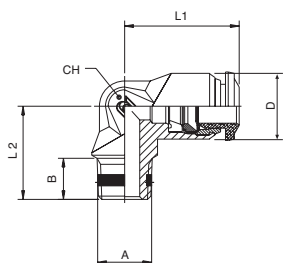

Код Code	Трубка Tube	A	B	L1	L2	CH	D	Упак. Pack.
5710000001	4	M5	5	17	15	9	10	10
5710000002	4	1/8	7.5	17	15.5	9	10	10
5710000010	5	M5	5	20	17	11	12.5	10
5710000011	5	1/8	7.5	20	17.5	11	12.5	10
5710000003	6	1/8	7.5	21	17.5	11	12.5	10
5710000012	6	1/4	11	21	21.5	11	12.5	10
5710000004	8	1/8	7.5	22.5	19	13	14	10
5710000005	8	1/4	11	22.5	21.5	13	14	10
5710000006	10	1/4	11	26.5	24.5	16	17	10
5710000007	10	3/8	11.5	26.5	24	16	17	10
5710000008	12	1/4	11	30.5	28	19	21.5	10
5710000009	12	3/8	11.5	30.5	28	19	21.5	10

57106

УГЛОВОЕ ПОВОРОТНОЕ СОЕДИНЕНИЕ ВНУТРЕННЯЯ РЕЗЬБА - ORIENTING ELBOW FEMALE ADAPTOR

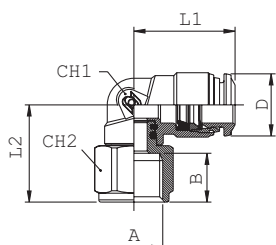

Код Code	Трубка Tube	A	B	L1	L2	CH1	CH2	D	Упак. Pack.
5710600001	4 1/8	8.5	18	20	9	13	10	10	
5710600002	4 1/4	11	18	21.5	9	16	10	10	
5710600003	6 1/8	8.5	21	20.5	11	13	12.5	10	
5710600004	6 1/4	11	21	23	11	16	12.5	10	
5710600005	8 1/8	8.5	22.5	20.5	12	13	14.5	10	
5710600006	8 1/4	11	22.5	23	12	16	14.5	10	

57111

УГЛОВОЕ ПОВОРОТНОЕ СОЕДИНЕНИЕ НАРУЖНЯЯ РЕЗЬБА (SHORT) - ORIENTING ELBOW MALE ADAPTOR (SHORT)

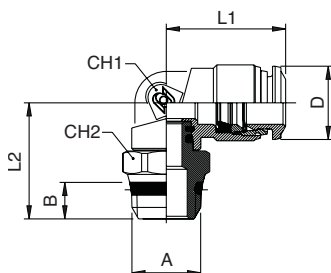

Код Code	Трубка Tube	A	B	L1	L2	CH	CH2	D	Упак. Pack.
*8911100003	4 (5/32)1/8	5.5	18	19.5	9	13	10	10	
*8911100004	4 (5/32)1/4	7	18	21	9	15	10	10	
5711100004	6 1/8	5.5	21	21.5	11	13	12.5	10	
5711100005	6 1/4	7	21	23	11	15	12.5	10	
*8911100008	8 (5/16)1/8	5.5	22.5	22.5	12	13	14.5	10	
*8911100009	8 (5/16)1/4	7	22.5	22.5	12	15	14.5	10	
*8911100010	8 (5/16)3/8	7.5	22.5	23	12	17	14.5	10	
*8911100018	8 (5/16)1/2	9	22.5	25.5	12	21	14.5	10	
5711100010	10 1/4	7	26.5	26.5	14	16	17.5	10	
5711100011	10 3/8	7.5	26.5	24.5	14	17	17.5	10	
5711100012	10 1/2	9	26.5	27	14	21	17.5	10	
5711100013	12 3/8	7.5	31.5	26.5	16	20	21.5	10	
5711100014	12 1/2	9	31.5	29	16	21	21.5	10	
5711100015	14 3/8	7.5	31.5	27	16	20	21.5	10	
5711100016	14 1/2	9	31.5	29.5	16	21	21.5	10	

*Фитинги серии 89000 для дюймовых труб
* Items in common with series 89000 for inch tubes

57116

УГЛОВОЕ ПОВОРОТНОЕ СОЕДИНЕНИЕ НАРУЖНЯЯ РЕЗЬБА (ЦИЛИНДРИЧЕСКАЯ) - ORIENTING ELBOW MALE ADAPTOR (PARALLEL)

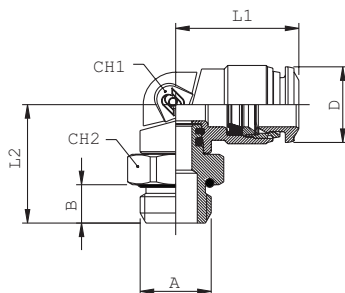

Код Code	Трубка Tube	A	B	L1	L2	CH1	CH2	D	Упак. Pack.
571160002	4	M5	3.5	18	17.5	9	8	10	10
571160003	4	1/8	5.5	18	18	9	13	10	10
571160004	4	1/4	7	18	18	9	16	10	10
571160005	5	M5	3.5	20	20	11	11	12.5	10
571160006	5	1/8	5.5	20	20	11	13	12.5	10
571160007	6	M5	3.5	21	20	11	11	12.5	10
571160008	6	1/8	5.5	21	20	11	13	12.5	10
571160009	6	1/4	7	21	21.5	11	16	12.5	10
571160010	8	1/8	5.5	22.5	21	12	13	14.5	10
571160011	8	1/4	7	22.5	21.5	12	16	14.5	10
571160012	8	3/8	8	22.5	23.5	12	20	14.5	10
571160013	8	1/2	9.5	22.5	25	12	25	14.5	10
571160014	10	1/4	7	26.5	25.5	14	16	17.5	10
571160015	10	3/8	8	26.5	25	14	20	17.5	10
571160016	10	1/2	9.5	26.5	26.5	14	25	17.5	10
571160025	12	1/4	8	31.5	27.5	16	20	21.5	10
571160017	12	3/8	8	31.5	27	16	20	21.5	10
571160018	12	1/2	9.5	31.5	28.5	16	25	21.5	10
571160019	14	3/8	8	31.5	27.5	16	20	21.5	10
571160020	14	1/2	9.5	31.5	29	16	25	21.5	10
571160021	6	M12x1	7.5	20	22	11	16	12.5	10
571160022	6	M12x1.25	7.5	20	22	11	16	12.5	10
571160023	6	M12x1.5	7.5	20	22	11	16	12.5	10
571160024	8	M12x1.5	7.5	22.5	22	12	16	14.5	10

57126

УГЛОВОЕ ПОВОРОТНОЕ СОЕДИНЕНИЕ НАРУЖНЯЯ РЕЗЬБА (ЦИЛИНДРИЧЕСКАЯ) - EXTENDED ORIENTING ELBOW MALE ADAPTOR (PARALLEL)

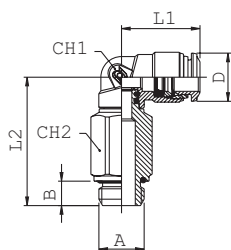

Код Code	Трубка Tube	A	B	L1	L2	CH1	CH2	D	Упак. Pack.
571260001	4	1/8	5.5	18	30	9	12	10	10
571260002	4	1/4	7	18	32	9	15	10	10
571260003	5	1/8	5.5	20	34.5	11	12	12.5	10
571260004	6	1/8	5.5	21	34.5	11	12	12.5	10
571260005	6	1/4	7	21	36	11	15	12.5	10
571260006	8	1/8	5	22.8	37.5	12	12	14.5	10
571260007	8	1/4	7	22.5	38	12	15	14.5	10
571260008	8	3/8	8	22.5	40	12	18	14.5	10
571260009	10	1/4	7	26.5	45	14	16	17.5	10
571260010	10	3/8	8	26.5	44.5	14	18	17.5	10

57130

УГЛОВОЕ СОЕДИНЕНИЕ - ELBOW CONNECTOR

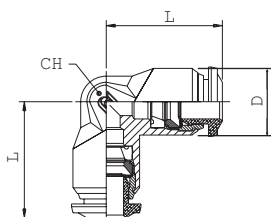

Код Code	Трубка Tube	L	CH	D	Упак. Pack.
*571300001	4 (5/32)	17	9	10	10
571300006	5	20	11	12.5	10
571300002	6	21	11	12.5	10
*571300003	8 (5/16)	22.5	13	14	10
571300004	10	26.5	16	17	10
571300005	12	30.5	19	21.5	10
571300008	14	32.5	19	21.5	10

*Фитинги серии 89000 для дюймовых труб
 * Items in common with series 89000 for inch tubes

57200

ТРОЙНИК Т-образный НАРУЖНЯЯ РЕЗЬБА (КОНИЧЕСКАЯ) - TEE MALE ADAPTOR (TAPER) CENTRE LEG

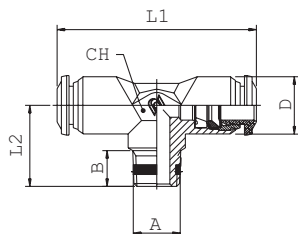

Код Code	Трубка Tube	A	B	L1	L2	CH	D	Упак. Pack.
572000001	4	M5	5	34	15	9	10	10
572000002	4	1/8	7.5	34	15.5	9	10	10
572000010	5	1/8	7.5	40	17.5	11	12.5	10
572000003	6	1/8	7.5	42	17.5	11	12.5	10
572000004	8	1/8	7.5	45	19	13	14	10
572000005	8	1/4	11	45	21.5	13	14	10
572000006	10	1/4	11	53	24.5	16	17	10
572000007	10	3/8	11.5	53	24	16	17	10
572000008	12	1/4	11	61	28	19	21.5	10
572000009	12	3/8	11.5	61	28	19	21.5	10

57211

ТРОЙНИК ПОВОРОТНЫЙ Т-образный НАРУЖНЯЯ РЕЗЬБА (SHORT) - ORIENTING TEE MALE ADAPTOR (SHORT) - CENTRE LEG

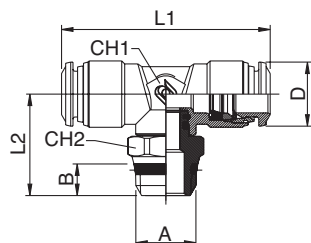

Код Code	Трубка Tube	A	B	L1	L2	CH1	CH2	D	Упак. Pack.
*892110003	4 (5/32)1/8	5.5	34	20	9	13	10	10	
*892110004	4 (5/32)1/4	7	34	21.5	9	15	10	10	
5721100004	6	1/8	5.5	42	22	11	13	12.5	10
5721100005	6	1/4	7	42	23.5	11	15	12.5	10
*8921100016	8 (5/16)1/8	5.5	45	25.5	13	13	14.5	10	
*8921100015	8 (5/16)1/4	7	45	25.5	13	15	14.5	10	
*8921100017	8 (5/16)3/8	7.5	45	26	13	17	14.5	10	
5721100010	10	1/4	7	53	29	14	16	17.5	10
5721100011	10	3/8	7.5	53	27	14	17	17.5	10
5721100012	10	1/2	9	53	29.5	14	21	17.5	10
5721100013	12	3/8	7.5	62.5	29.5	16	20	21.5	10
5721100014	12	1/2	9	62.5	32	16	21	21.5	10

*Фитинги серии 89000 для дюймовых труб
 * Items in common with series 89000 for inch tubes

57216

ТРОЙНИК ПОВОРОТНЫЙ Т-образный НАРУЖНЯЯ РЕЗЬБА (ЦИЛИНДРИЧЕСКАЯ) - ORIENTING TEE MALE ADAPTOR (PARALLEL) CENTRE LEG

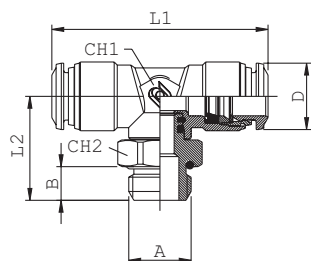

Код Code	Трубка Tube	A	B	L1	L2	CH1	CH2	D	Упак. Pack.
5721600002	4	M5	3.5	34	18	9	8	10	10
5721600003	4	1/8	5.5	34	18.5	9	13	10	10
5721600004	4	1/4	7	34	20	9	16	10	10
5721600005	5	M5	3.5	40	20.5	11	11	12.5	10
5721600006	5	1/8	5.5	40	20.5	11	13	12.5	10
5721600007	6	M5	3.5	42	20.5	11	11	12.5	10
5721600008	6	1/8	5.5	42	20.5	11	13	12.5	10
5721600009	6	1/4	7	42	22	11	16	12.5	10
5721600010	8	1/8	5.5	45	23.5	13	13	14.5	10
5721600011	8	1/4	7	45	24	13	16	14.5	10
5721600012	8	3/8	8	45	26	13	20	14.5	10
5721600013	8	1/2	9.5	45	27.5	13	25	14.5	10
5721600014	10	1/4	7	53	27.5	14	16	17.5	10
5721600015	10	3/8	8	53	27	14	20	17.5	10
5721600016	10	1/2	9.5	53	28.5	14	25	17.5	10
5721600017	12	3/8	8	62.5	29.5	16	20	21.5	10
5721600018	12	1/2	9.5	62.5	31	16	25	21.5	10
5721600019	14	3/8	8	62.5	29.5	16	20	21.5	10
5721600020	14	1/2	9.5	62.5	31	16	25	21.5	10
5721600021	6	M12x1	7.5	42	22	11	16	12.5	10
5721600022	6	M12x1.25	7.5	42	22	11	16	12.5	10
5721600023	6	M12x1.5	7.5	42	22	11	16	12.5	10

57223

ТРОЙНИК ПОВОРОТНЫЙ Т-образный НАРУЖНЯЯ РЕЗЬБА (SHORT) - ORIENTING TEE MALE ADAPTOR (SHORT) OFF - SET LEG

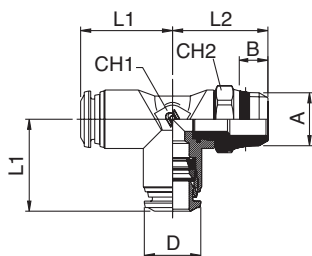

Код Code	Трубка Tube	A	B	L1	L2	CH1	CH2	D	Упак. Pack.
*8922300003	4 (5/32)	1/8	5.5	17	20	9	13	10	10
*8922300004	4 (5/32)	1/4	7	17	21.5	9	15	10	10
5722300004	6	1/8	5.5	21	22	11	13	12.5	10
5722300005	6	1/4	7	21	23.5	11	15	12.5	10
*8922300015	8 (5/16)	1/8	5.5	22.5	24	13	13	14.5	10
*8922300016	8 (5/16)	1/4	7	22.5	24	13	15	14.5	10
*8922300017	8 (5/16)	3/8	7.5	22.5	27	13	17	14.5	10
5722300010	10	1/4	7	26.5	26	14	16	17.5	10
5722300011	10	3/8	7.5	26.5	26	14	17	17.5	10
5722300012	10	1/2	9	26.5	28.5	14	21	17.5	10
5722300013	12	3/8	7.5	31.5	29.5	16	20	21.5	10
5722300014	12	1/2	9	31.5	32	16	21	21.5	10

*Фитинги серии 89000 для дюймовых труб
* Items in common with series 89000 for inch tubes

57226

ТРОЙНИК ПОВОРОТНЫЙ Т-образный НАРУЖНЯЯ РЕЗЬБА (ЦИЛИНДРИЧЕСКАЯ) - ORIENTING TEE MALE ADAPTOR (PARALLEL) OFF - SET LEG

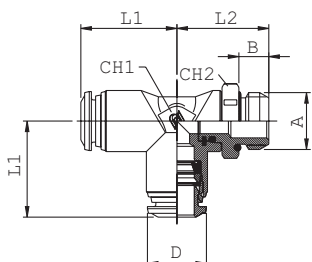

Код Code	Трубка Tube	A	B	L1	L2	CH1	CH2	D	Упак. Pack.
5722600002	4	M5	3.5	17	18	9	8	10	10
5722600003	4	1/8	5.5	17	18.5	9	13	10	10
5722600004	4	1/4	7	17	20	9	16	10	10
5722600005	5	M5	3.5	20	20.5	11	11	12.5	10
5722600006	5	1/8	5.5	20	20.5	11	13	12.5	10
5722600007	6	M5	3.5	21	20.5	11	11	12.5	10
5722600008	6	1/8	5.5	21	20.5	11	13	12.5	10
5722600009	6	1/4	7	21	22	11	16	12.5	10
5722600010	8	1/8	5.5	22.5	22.5	13	13	14.5	10
5722600011	8	1/4	7	22.5	23	13	16	14.5	10
5722600012	8	3/8	8	22.5	25	13	20	14.5	10
5722600013	8	1/2	9.5	22.5	26.5	13	25	14.5	10
5722600014	10	1/4	7	26.5	27	14	16	17.5	10
5722600015	10	3/8	8	26.5	26.5	14	20	17.5	10
5722600016	10	1/2	9.5	26.5	28	14	25	17.5	10
5722600017	12	3/8	8	31.5	29.5	16	20	21.5	10
5722600018	12	1/2	9.5	31.5	31	16	25	21.5	10
5722600021	6	M12x1	7.5	21	22	11	16	12.5	10
5722600022	6	M12x1.25	7.5	21	22	11	16	12.5	10
5722600023	6	M12x1.5	7.5	21	22	11	16	12.5	10

57230

ТРОЙНИК Т-образный - TEE CONNECTOR

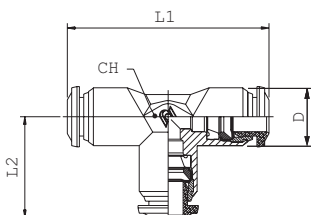

Код Code	Трубка Tube	L1	L2	CH	D	Упак. Pack.
*5723000001	4 (5/32)	34	17	9	10	10
5723000006	5	40	20	11	12.5	10
5723000002	6	42	21	11	12.5	10
*5723000003	8 (5/16)	45	22.5	13	14	10
5723000004	10	53	26.5	16	17	10
5723000005	12	61	30.5	19	21.5	10
5723000008	14	65.5	32.5	19	21.5	10

*Фитинги серии 89000 для дюймовых труб
* Items in common with series 89000 for inch tubes

57310

ТРОЙНИК Уобразный - Y CONNECTOR

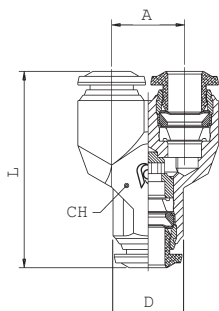

Код Code	Трубка Tube	A	L	CH	D	Упак. Pack.
*5731000001	4 (5/32)	11	32	11	10	10
5731000004	5	13.5	35	13	12.5	10
5731000002	6	13.5	36.5	13	12.5	10
*5731000003	8 (5/16)	15.5	41	15	14	10
5731000008	10	18.5	48	18	17	10

*Фитинги серии 89000 для дюймовых труб
* Items in common with series 89000 for inch tubes

57500

СОЕДИНЕНИЕ БАНДЖО - SINGLE BANJO BODY

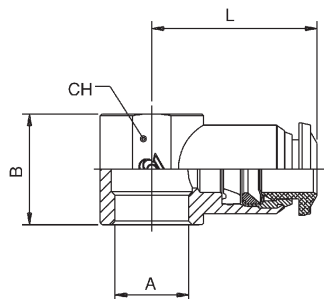

Код Code	Трубка Tube	A	B	L	CH	D	Упак. Pack.
575000001	4 (5/32) M5 (10/32)	12.5	19	-	10	10	10
575000002	4	M6	12.5	19	-	10	10
575000003	4 (5/32)	1/8	15	21	14	10	10
575000013	5	M5	12.5	20	-	12.5	10
575000017	5	M6	12.5	20	-	12.5	10
575000014	5	1/8	15	21.5	14	12.5	10
575000015	5	1/4	17	24.5	18	12.5	10
575000016	6	M5	12.5	20.5	-	12.5	10
575000018	6	M6	12.5	20.5	-	12.5	10
575000004	6	1/8	15	22	14	12.5	10
575000005	6	1/4	17	25	18	12.5	10
575000006	8	1/8	15	24	14	14	10
575000007	8	1/4	17	26	18	14	10
575000008	8	3/8	20	28	21	14	10
575000009	10	1/4	17	29	18	17	10
575000010	10	3/8	20	30.5	21	17	10
575000012	12	3/8	20	32.5	21	21.5	10
575000021	12	1/2	24	35	25	21.5	10
575000022	14	1/2	24	35.5	25	21.5	10

*Фитинги серии 89000 для дюймовых труб
 * Items in common with series 89000 for inch tubes

57510

СОЕДИНЕНИЕ БАНДЖО - DOUBLE BANJO BODY

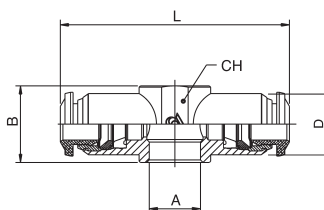

Код Code	Трубка Tube	A	B	L	CH	D	Упак. Pack.
575100001	4	M5	12.5	38	-	10	10
575100002	4	M6	12.5	38	-	10	10
575100003	4	1/8	15	42	14	10	10
575100008	5	1/8	15	43	14	12.5	10
575100009	5	1/4	17	49	18	12.5	10
575100004	6	1/8	15	44	14	12.5	10
575100005	6	1/4	17	50	18	12.5	10
575100006	8	1/8	15	48	14	14	10
575100007	8	1/4	17	52	18	14	10

57550

СОЕДИНЕНИЕ БАНДЖО С НАРУЖНОЙ РЕЗЬБОЙ (ЦИЛИНДРИЧЕСКАЯ) - ORIENTING SINGLE BANJO BODY MALE

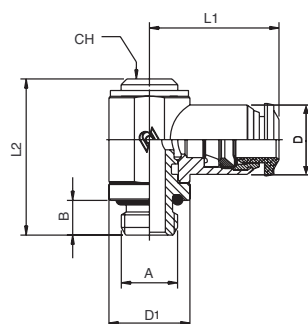

Код Code	Трубка Tube	A	B	L1	L2	CH	D1	D	Упак. Pack.
575500001	4	M5	5	19	24.5	-	9	10	10
575500002	4	1/8	6	21	28	5	14	10	10
575500012	5	M5	5	20	24.5	-	9	12.5	10
575500013	5	1/8	6	21.5	28	5	14	12.5	10
575500014	5	1/4	8	24.5	31	6	18	12.5	10
575500015	6	M5	5	20.5	24.5	-	9	12.5	10
575500003	6	1/8	6	22.5	28	5	14	12.5	10
575500004	6	1/4	8	25	31	6	18	12.5	10
575500005	8	1/8	6	24	28	5	14	14	10
575500006	8	1/4	8	26	31	6	18	14	10
575500007	8	3/8	9	28	35.5	7	21	14	10
575500008	10	1/4	8	29	31	6	18	17	10
575500009	10	3/8	9	30.5	35.5	7	21	17	10
575500011	12	3/8	9	32.5	35.5	7	21	21.5	10

57560

СОЕДИНЕНИЕ БАНДЖО С НАРУЖНОЙ РЕЗЬБОЙ (ЦИЛИНДРИЧЕСКАЯ) - ORIENTING DOUBLE BANJO BODY MALE

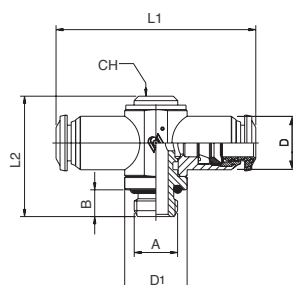

Код Code	Трубка Tube	A	B	L1	L2	D1	CH	D	Упак. Pack.
575600002	4	1/8	6	42	27	14	5	10	10
575600008	5	1/8	6	43	27	14	5	12.5	10
575600009	5	1/4	8	49	31	18	6	12.5	10
575600003	6	1/8	6	45	27	14	5	12.5	10
575600004	6	1/4	8	50	31	18	6	12.5	10
575600005	8	1/8	6	48	27	14	5	14	10
575600006	8	1/4	8	52	31	18	6	14	10

51410

БОЛТ БАНДЖО ОДИНАРНЫЙ - BANJO STEM SINGLE

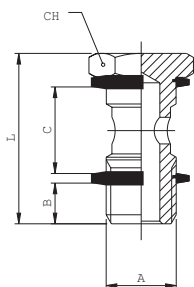

Код Code	A	B	C	L	CH	Упак. Pack.
5141000011	M5	4	12.5	22	8	25
5141000012	M6	5	12.5	23	8	25
5141000013	1/8	6	15	28	14	25
5141000014	1/4	8	17	32	17	25
5141000015	3/8	9	20	36	19	25
5141000016	1/2	10	24	42	24	25
5141000017	*M12x1.58	17	32	17		25

ДАННОЕ ИЗДЕЛИЕ ПОСТАВЛЯЕТСЯ С ЦАНГОЙ PA66 (ART. 1610).
THIS ITEM WILL BE SUPPLIED WITH THE PA66 WASHERS (ART. 1610).

*ИСПОЛЬЗУЕТСЯ В ПОВОРОТНЫХ СОЕДИНЕНИЯХ БАНДЖО 1/4.
*WITH THIS BANJO STEM USING 1/4 ORIENTING BANJO BODY.

51420

БОЛТ БАНДЖО ДВОЙНОЙ - BANJO STEM DOUBLE

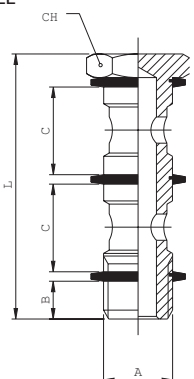

Код Code	A	B	C	L	CH	Упак. Pack.
5142000011	1/8	6	15	44.5	14	25
5142000012	1/4	8	17	50.5	17	25
5142000013	3/8	9	20	58	19	25
5142000014	1/2	10	24	68	24	25
5142000015	*M12x1.5	8	17	50.5	17	25

ДАННОЕ ИЗДЕЛИЕ ПОСТАВЛЯЕТСЯ С ЦАНГОЙ PA66 (ART. 1610).
THIS ITEM WILL BE SUPPLIED WITH THE PA66 WASHERS (ART. 1610).

*CON QUESTA VITE UTILIZZARE GLI ANELLI ORIENTABILI DA 1/4.
*ИСПОЛЬЗУЕТСЯ В ПОВОРОТНЫХ СОЕДИНЕНИЯХ БАНДЖО 1/4

51430

БОЛТ БАНДЖО ТРОЙНОЙ - BANJO STEM TRIPLE

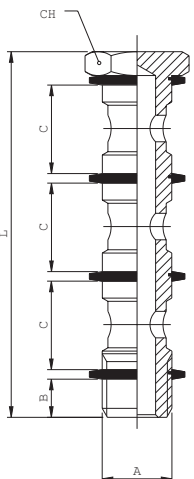

Код Code	A	B	C	L	CH	Упак. Pack.
5143000011	1/8	6	15	61	14	25
5143000012	1/4	8	17	69	17	25
5143000013	3/8	9	20	80	19	25
5143000014	1/2	10	24	94	24	10

ДАННОЕ ИЗДЕЛИЕ ПОСТАВЛЯЕТСЯ С ЦАНГОЙ PA66 (ART. 1610).
THIS ITEM WILL BE SUPPLIED WITH THE PA66 WASHERS (ART. 1610).

51440

БОЛТ БАНДЖО - MALE - FEMALE BANJO STEM SINGLE

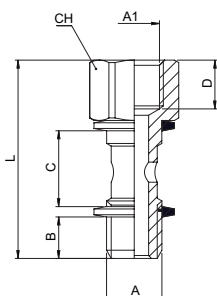

Код Code	A	A1	B	C	D	L	CH	Упак. Pack.
5144000001	1/8	1/8	6	15	8.5	34.5	14	25
5144000002	1/4	1/4	8	17	11	40.5	17	25
5144000003	3/8	3/8	9	20	12	45.5	19	25

ДАННОЕ ИЗДЕЛИЕ ПОСТАВЛЯЕТСЯ С ЦАНГОЙ PA66 (ART. 1610).
THIS ITEM WILL BE SUPPLIED WITH THE PA66 WASHERS (ART. 1610).

50600

СОЕДИНЕНИЕ НАРУЖНАЯ РЕЗЬБА (ЦИЛИНДРИЧЕСКАЯ) - MALE ADAPTOR PARALLEL

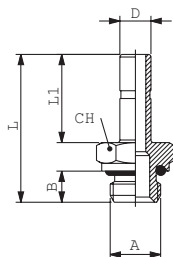

Код Code	D	A	B	L	L1	CH	Упак. Pack.
506000001	4	M5	4	24	15	8	10
506000002	4	1/8	6	26.5	15	13	10
506000012	5	M5	4	26	17	8	10
506000013	5	1/8	6	28.5	17	13	10
506000014	5	1/4	8	31	17	16	10
506000015	6	M5	4	26	17	8	10
506000003	6	1/8	6	28.5	17	13	10
506000004	6	1/4	8	31	17	16	10
506000005	8	1/8	6	29.5	18	13	10
506000006	8	1/4	8	32	18	16	10
506000007	8	3/8	9	33.5	18	20	10
506000016	10	1/8	6	33.5	22	13	10
506000008	10	1/4	8	36	22	16	10
506000009	10	3/8	9	37.5	22	20	10
506000010	12	1/4	8	38.5	24.5	16	10
506000011	12	3/8	9	40	24.5	20	10

8610

ПОЛИАМИДНАЯ ЗАГЛУШКА - POLYAMIDE PLUG

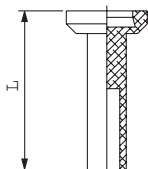

Код Code	Трубка Tube	L	Упак. Pack.
086100031X0RO	3	18	25
086100031X1RO	4	23.5	25
086100031X3RO	5	24.5	25
086100031X4RO	6	24.5	25
086100031X7RO	8	26	25
086100031X9RO	10	28.5	25
086100031Y1RO	12	28.5	25
086100031Y3RO	14	28.5	20

50625

ДВОЙНОЕ СОЕДИНЕНИЕ - DOUBLE JOINT

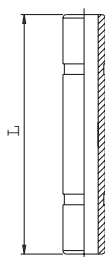

Код Code	Трубка Tube	L	Упак. Pack.
506250001X1NB	4	31	10
506250001X3NB	5	33	10
506250001X4NB	6	34	10
506250001X7NB	8	36	10
506250001X9NB	10	45	10
506250001Y1NB	12	50	10

57700

ПЕРЕХОДНИК - REDUCER

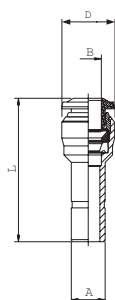

Код Code	A	B	L	D	Упак. Pack.
577000004	5	4	29	12.5	10
577000001	6	4	30	12.5	10
577000005	6	5	32	12.5	10
577000008	8	4	33	14	10
577000002	8	6	34	14	10
577000009	10	4	32	17	10
577000003	10	8	38	17	10
577000007	12	8	39	21.5	10
577000010	12	10	43	17.5	10

57800

ФИТИНГ-КАРТРИДЖ - PUSH-FIT CARTRIDGES

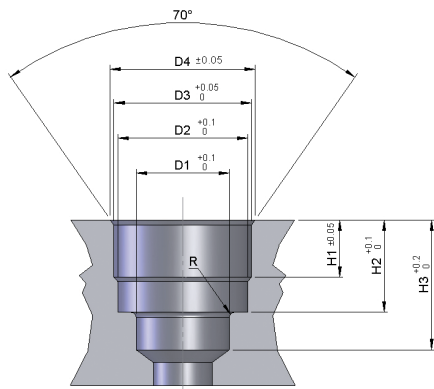
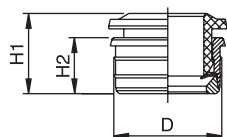

Код Code	Трубка Tube	D	H1	H2	Упак. Pack.
578000001	4	8.7	10.4	5.6	25
578000002	5	9.75	11.8	6.3	25
578000003	6	10.75	12.4	6.9	25
578000004	8	12.7	12.4	6.9	25
578000005	10	15.7	15.7	8.5	25
578000006	12	18.3	17.8	9.5	25

57800

SEDE - SEAT

 ПОСАДОЧНЫЕ РАЗМЕРЫ ПОД ФИТИНГ_КАРТРИДЖSEATS DIMENSIONS
 PUSH-FIT CARTRIDGES

Трубка Tube	D1	D2	D3	D4	H1	H2	H3	R
4	4.2	7.45	8.4	9	3.75	6.5	9.5	0.5
5	5.2	8.35	9.4	10.15	4.45	7.9	10.5	0.5
6	6.2	9.35	10.45	11.35	5	8.5	11.5	0.5
8	8.2	11.4	12.4	12.9	5.2	8.5	12.5	0.75
10	10.2	14.5	15.4	16	6.7	10.5	15	0.75
12	12.2	17	18	19	7.5	12.1	17	1

55801

СВЕРЛО

TOOL FOR PUSH-FIT CARTRIDGES SEAT



Код Code	Трубка Tube	Корпуса Body	Упак. Pack.
5580100001	4	10	1
5580100006	5	12	1
5580100002	6	12	1
5580100003	8	12	1
5580100004	10	16	1
5580100005	12	16	1

55802

 ИНСТРУМЕНТ ДЛЯ УСТАНОВКИ ФИТИНГА-КАРТРИДЖА
 ASSEMBLING TOOL FOR PUSH-FIT CARTRIDGES



Код Code	Трубка Tube	Упак. Pack.
5580200002	4	1
5580200003	5	1
5580200004	6	1
5580200005	8	1
5580200006	10	1
5580200007	12	1

ИНСТРУКЦИЯ ПО УСТАНОВКЕ ФИТИНГА-КАРТРИДЖА ART. 57800 PUSH-FIT CARTRIDGES ASSEMBLING INSTRUCTIONS ART. 57800

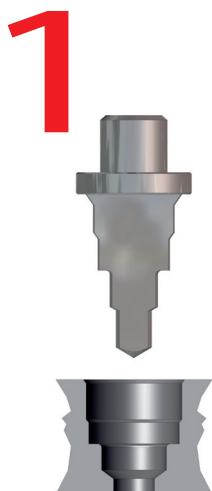
Просверлите отверстие с помощью сверла Art. 55801
 Make the seat for the cartridge utilizing the suitable tool Art. 55801

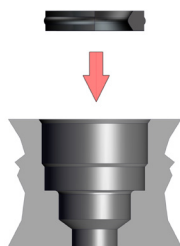

2



Установите прокладку в отверстие.
 Insert the lip seal inside of the seat.

ПОМЕСТИТЕ КАРТРИДЖ В ИНСТРУМЕНТ ДЛЯ УСТАНОВКИ Art. 55802
 Insert the cartridge into the assembling tool Art. 55802



3

4



Запресуйте картридж при помощи инструмента для установки в посадочное отверстие до упора.
 Press the cartridge inside of the seat until it will be reached the abutment surface with the assembling tool.

50980

СТОПОРНАЯ КЛИПСА - SECURITY CLIPS

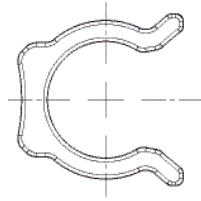

NEW

Код Code	Трубка Tube	Упак. Pack.
509800032X1RO	4-(5/32)	50
509800032X3RO	5	50
509800032X4RO	6-(1/4)	50
509800032X7RO	8-(5/16)	50
509800032X9RO	10-(3/8)	50
509800032Y1RO	12-(1/2)	50
509800032Y3RO	14	50

50990

СЪЕМНИК - TOOL FOR DISASSEMBLING

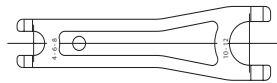

Код Code	Упак. Pack.
5099000001	10

50006

РЕЗЬБОВЫЕ УПЛОТНЕНИЯ - THREAD PACKING FOR TAPER THREADS



Код Code	Резьба Thread	Упак. Pack.
5000600240200	1/8	10
5000600240300	1/4	10
5000600240400	3/8	10
5000600240500	1/2	10

